



VAN OPSTAL
B e n e l u x

Van Opstal & C° s.a.

Boomsesteenweg 34, B- 2630 Aartselaar

Tel.: 03- 887.40.48 • Fax: 03- 887.76.06

E-mail: info@vanopstal.be

www.vanopstal.be

Van Opstal Nederland b.v.

Minden 56, NL- 7327 AW Apeldoorn

Tel.: 055- 543.03.33 • Fax: 055- 543.00.09

E-mail: info@vanopstal.nl

www.vanopstal.nl



QUINCAILLERIE DÉCORATIVE

© Toute reproduction, même partielle,
est interdite sans autorisation écrite de
Van Opstal & C° s.a.

Index

Accessoires	76
Arrêts de porte	78
Boutons en nylon	1
Boutons et poignées en Britannium	64
Boutons et poignées en fer forgé.....	49
Poignées de porte et accessoires	81
Poignées en acier	13
Poignées en PVC.....	2
Poignées et accessoires en laiton.....	15
Poignées et boutons en aluminium	3
Poignées et boutons en cuir.....	69
Poignées et boutons en inox	6
Poignées et boutons en zamac	21
Poignées longues.....	70
Poignées pour portes coulissantes	73

Notes



BOUTONS EN NYLON







BOUTONS EN NYLON ESTAMP



Boutons en nylon type Babyline

- fixation: 1 x M4

- par pièce







N° de com.	Finition						
059452	ours - rose	14 mm	47 mm	24 mm	12 mm	37 mm	12
059453	lapin - bleu	14 mm	58 mm	24 mm	12 mm	35 mm	12



Boutons en nylon type Kidline

- fixation: 1 x M4

- par pièce

N° de com.	Finition						
059450	voiture - rouge	14 mm	51 mm	20 mm	12 mm	31 mm	12
059451	arbre - vert	14 mm	51 mm	20 mm	12 mm	48 mm	12
058844	bateau - bleu	14 mm	51 mm	21 mm	12 mm	35 mm	12
058848	grenouille - verte	14 mm	51 mm	22 mm	12 mm	37 mm	12

POIGNÉES EN PVC







POIGNÉES EN PVC



Poignée courbée en PVC type 48.0090

- fixation: 2 x vis à bois Ø 3,5 mm

- par pièce

N° de com.	Finition	 E	 L	 H	 h	 L	
055101	blanc	96 mm	106 mm	30 mm	20 mm	10 mm	1

POIGNÉES ET BOUTONS EN ALUMINIUM

BOUTONS EN ALUMINIUM ESTAMP



Boutons en aluminium et matière synthétique

- fixation: 1 x M4

- par pièce

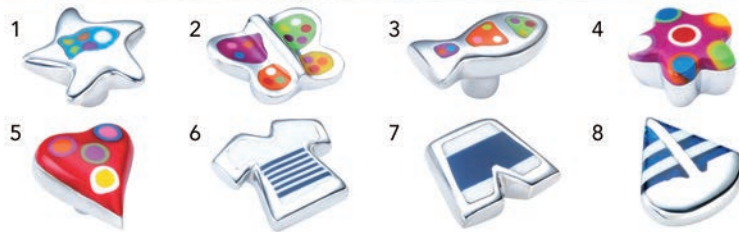

N° de com.	Description						
058836	étoile + poisson (1)	16 mm	48 mm	27 mm	12 mm	48 mm	12
058837	papillon (2)	16 mm	57 mm	30 mm	10 mm	52 mm	12
058838	poisson (3)	16 mm	53 mm	25 mm	14 mm	25 mm	12
058839	étoile + cercle (4)	16 mm	35 mm	36 mm	16 mm	35 mm	12
058840	coeur (5)	17 mm	51 mm	36 mm	13 mm	45 mm	12
058841	T-shirt (6)	15 mm	48 mm	25 mm	12 mm	46 mm	12
058842	short (7)	15 mm	45 mm	26 mm	12 mm	37 mm	12
058843	bateau (8)	15 mm	50 mm	28 mm	13 mm	47 mm	12

POIGNÉES EN ALUMINIUM METAKOR



Poignée en aluminium type Vienna

- fixation: 2 x M4

- par pièce

N° de com.	Finition						
058714	alu mat	64 mm	114 mm	20 mm	-	24 mm	1
058715	alu mat	128 mm	220 mm	20 mm	-	24 mm	1
058717	alu mat	192 mm	320 mm	20 mm	-	24 mm	1

PROFILS POIGNÉES EN ALUMINIUM SCHÜCO

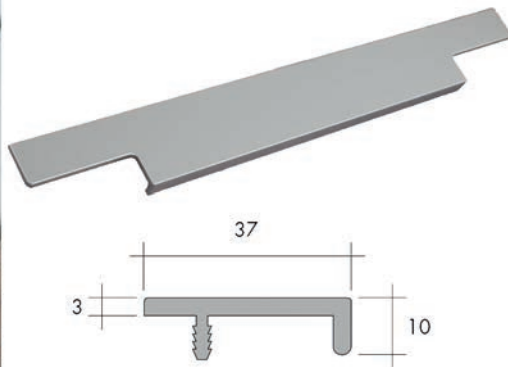

Poignée profil en zamac type 901.365
- par pièce

N° de com.	Finition	E	L	H	h	L	
047579	anodisée mat	-	295 mm	10 mm	-	37 mm	20
047580	anodisée mat	-	395 mm	10 mm	-	37 mm	20
047581	anodisée mat	-	445 mm	10 mm	-	37 mm	20
047582	anodisée mat	-	495 mm	10 mm	-	37 mm	20
047583	mat anodisée	-	595 mm	10 mm	-	37 mm	20
047584	mat anodisée	-	795 mm	10 mm	-	37 mm	20
047585	anodisée mat	-	895 mm	10 mm	-	37 mm	20
047586	anodisée mat	-	1195 mm	10 mm	-	37 mm	20
047587	inox look	-	295 mm	10 mm	-	37 mm	20
047588	inox look	-	395 mm	10 mm	-	37 mm	20
047589	inox look	-	445 mm	10 mm	-	37 mm	20
047590	inox look	-	495 mm	10 mm	-	37 mm	20
047591	inox look	-	595 mm	10 mm	-	37 mm	20
047592	inox look	-	795 mm	10 mm	-	37 mm	20
047593	inox look	-	895 mm	10 mm	-	37 mm	20
047594	inox look	-	1195 mm	10 mm	-	37 mm	20

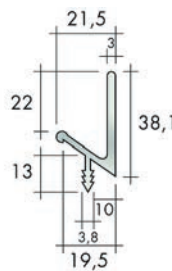

Profil poignée en aluminium type 901189
- par pièce

N° de com.	Finition	E	L	H	h	L	
047276	anodisée mat	-	295 mm	38,1 mm	-	21,5 mm	20
047277	anodisée mat	-	395 mm	38,1 mm	-	21,5 mm	20
047278	anodisée mat	-	445 mm	38,1 mm	-	21,5 mm	20
047279	anodisée mat	-	495 mm	38,1 mm	-	21,5 mm	20
047280	anodisée mat	-	595 mm	38,1 mm	-	21,5 mm	20
047281	anodisée mat	-	895 mm	38,1 mm	-	21,5 mm	20
047282	anodisée mat	-	1195 mm	38,1 mm	-	21,5 mm	20

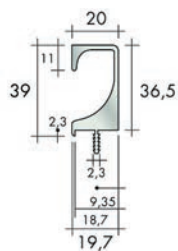
**Profil poignée en aluminium type 900303**

- par pièce

N° de com.	Finition	E	L	H	h	L	
047283	anodisée mat	-	295 mm	36,5 mm	-	20 mm	20
047284	anodisée mat	-	395 mm	36,5 mm	-	20 mm	20
047285	anodisée mat	-	445 mm	36,5 mm	-	20 mm	20
047286	anodisée mat	-	495 mm	36,5 mm	-	20 mm	20
047287	anodisée mat	-	595 mm	36,5 mm	-	20 mm	20
047288	anodisée mat	-	895 mm	36,5 mm	-	20 mm	20
047289	anodisée mat	-	1195 mm	36,5 mm	-	20 mm	20

POGNÉES EN ALUMINIUM

**Poignée en aluminium type AL26000**

- fixation: 2 x M4

- par pièce

N° de com.	Finition	E	L	H	d	P	
060902	noir mat brossé	128 mm	180 mm	15 mm	3 mm	24 mm	1
060903	noir mat brossé	160 mm	240 mm	15 mm	3 mm	24 mm	1
060904	noir mat brossé	320 mm	390 mm	15 mm	3 mm	24 mm	1

POIGNÉES ET BOUTONS EN INOX

POIGNÉES T EN INOX



Poignée en T en inox: perçage multiple de 32 mm

- inox massif
- fixation: 2 x M4
- * avec 3 pieds (3 x M4)

- par pièce

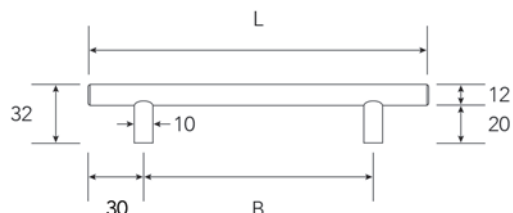

N° de com.	Finition	E	L	H	h	L	
060467	inox	64 mm	124 mm	32 mm	20 mm	12 mm	1
060468	inox	96 mm	156 mm	32 mm	20 mm	12 mm	1
060469	inox	128 mm	188 mm	32 mm	20 mm	12 mm	1
060470	inox	160 mm	220 mm	32 mm	20 mm	12 mm	1
060471	inox	192 mm	252 mm	32 mm	20 mm	12 mm	1
060472	inox	224 mm	284 mm	32 mm	20 mm	12 mm	1
060473	inox	256 mm	316 mm	32 mm	20 mm	12 mm	1
060474	inox	288 mm	348 mm	32 mm	20 mm	12 mm	1
060475	inox	320 mm	380 mm	32 mm	20 mm	12 mm	1
060476	inox	352 mm	412 mm	32 mm	20 mm	12 mm	1
060477	inox	384 mm	444 mm	32 mm	20 mm	12 mm	1
060478	inox	448 mm	508 mm	32 mm	20 mm	12 mm	1
060479	inox	480 mm	540 mm	32 mm	20 mm	12 mm	1
060480	inox	544 mm	604 mm	32 mm	20 mm	12 mm	1
060481	inox	640 mm	700 mm	32 mm	20 mm	12 mm	1
060482	inox	672 mm	732 mm	32 mm	20 mm	12 mm	1
060483	inox	736 mm	796 mm	32 mm	20 mm	12 mm	1
060484	inox	* 960 mm	1020 mm	32 mm	20 mm	12 mm	1
060485	inox	* 1280 mm	1340 mm	32 mm	20 mm	12 mm	1
060486	inox	* 1440 mm	1500 mm	32 mm	20 mm	12 mm	1



Poignée en T en inox: avec dimensions fixes comparées à la largeur de la façade du tiroir

- inox massif
- fixation: 2 x M4

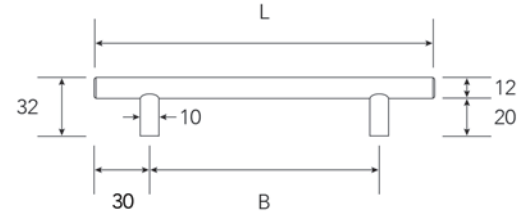
- par pièce

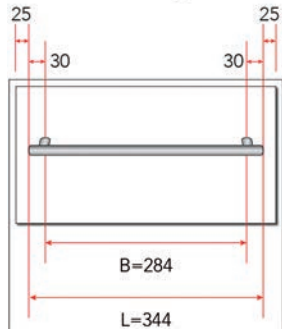

ex. armoire avec largeur 400 mm



ex. armoire avec largeur 600 mm

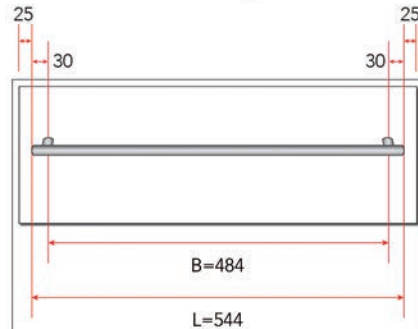

N° de com.	Finition / largeur armoire	E	L	H	h	L	
060490	inox / 300 mm	184 mm	244 mm	32 mm	20 mm	12 mm	1
060491	inox / 350 mm	234 mm	294 mm	32 mm	20 mm	12 mm	1
060492	inox / 400 mm	284 mm	344 mm	32 mm	20 mm	12 mm	1
060493	inox / 450 mm	334 mm	394 mm	32 mm	20 mm	12 mm	1
060494	inox / 500 mm	384 mm	444 mm	32 mm	20 mm	12 mm	1
060495	inox / 550 mm	434 mm	494 mm	32 mm	20 mm	12 mm	1
060496	inox / 600 mm	484 mm	544 mm	32 mm	20 mm	12 mm	1
060497	inox / 700 mm	584 mm	644 mm	32 mm	20 mm	12 mm	1
060498	inox / 800 mm	684 mm	744 mm	32 mm	20 mm	12 mm	1
060499	inox / 900 mm	784 mm	844 mm	32 mm	20 mm	12 mm	1
060500	inox / 1000 mm	884 mm	944 mm	32 mm	20 mm	12 mm	1
060501	inox / 1200 mm	1084 mm	1144 mm	32 mm	20 mm	12 mm	1

Poignée en T en inox: pour montage vertical sur la façade d'une armoire de frigo

- inox massif
- avec 3 pieds
- fixation: 3 x M4

- par pièce

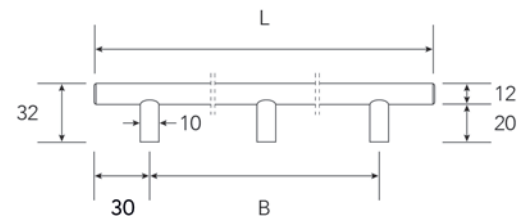

N° de com.	Finition / hauteur armoire	E	L	H	h	L	
060502	inox / 1100 mm	924 mm	984 mm	32 mm	20 mm	12 mm	1
060503	inox / 1300 mm	1092 mm	1152 mm	32 mm	20 mm	12 mm	1









Poignée en T en inox type T12

- matière première: inox AISI 304

- fixation: 2 x M4

- par pièce

N° de com.	Finition	 E	 L	 H	 h	 L	
016101	noir mat	96 mm	156 mm	32 mm	20 mm	12 mm	1
016102	noir mat	128 mm	188 mm	32 mm	20 mm	12 mm	1
016103	noir mat	160 mm	220 mm	32 mm	20 mm	12 mm	1
016104	noir mat	192 mm	252 mm	32 mm	20 mm	12 mm	1
016105	noir mat	224 mm	284 mm	32 mm	20 mm	12 mm	1







POIGNÉES EN INOX U



Poignée courbée en inox U

- fixation: 2 x M4

- par pièce

N° de com.	Finition	 E	 L	 H	 h	 L	
058169	inox brossée	32 mm	42 mm	35 mm	25 mm	10 mm	1
058170	inox brossée	64 mm	74 mm	35 mm	25 mm	10 mm	1
058171	inox brossée	96 mm	106 mm	35 mm	25 mm	10 mm	1
058172	inox brossée	128 mm	138 mm	35 mm	25 mm	10 mm	1
058173	inox brossée	160 mm	170 mm	35 mm	25 mm	10 mm	1
058174	inox brossée	192 mm	202 mm	35 mm	25 mm	10 mm	1

POIGNÉES COURBÉES EN INOX

**Poignée courbée en inox type A10537**

- fixation: 2 x M4

- par pièce

N° de com.	Finition	E	L	H	h	L	
058325	inox brossée	96 mm	106 mm	35 mm	25 mm	10 mm	40
058326	inox brossée	128 mm	138 mm	35 mm	25 mm	10 mm	40
058327	inox brossée	160 mm	170 mm	35 mm	25 mm	10 mm	40

**Poignée courbée en inox type I1021**

- fixation: 2 x M4

- par pièce

N° de com.	Finition	E	L	H	h	L	
058291	inox brossée	96 mm	108 mm	35 mm	23 mm	12 mm	1
058292	inox brossée	128 mm	139 mm	35 mm	23 mm	12 mm	1
058293	inox brossée	160 mm	172 mm	35 mm	23 mm	12 mm	1
058294	inox brossée	192 mm	204 mm	35 mm	23 mm	12 mm	1

**Poignée courbée en inox type I1020**

- fixation: 2 x M4

- par pièce

N° de com.	Finition	E	L	H	h	L	
058241	inox brossée	96 mm	118 mm	34 mm	22 mm	12 mm	1
058242	inox brossée	128 mm	150 mm	34 mm	22 mm	12 mm	1
058243	inox brossée	160 mm	182 mm	34 mm	22 mm	12 mm	1
058244	inox brossée	192 mm	214 mm	34 mm	22 mm	12 mm	1



Poignée courbée type URG12

- matière première: inox AISI 304

- fixation: 2 x M4

- par pièce

N° de com.	Finition	E	L	H	h	L	
016106	noir mat	96 mm	108 mm	36 mm	24 mm	12 mm	1
016107	noir mat	128 mm	140 mm	36 mm	24 mm	12 mm	1
016108	noir mat	160 mm	172 mm	36 mm	24 mm	12 mm	1
016109	noir mat	192 mm	204 mm	36 mm	24 mm	12 mm	1
016110	noir mat	285 mm	297 mm	36 mm	24 mm	12 mm	1



Poignée courbée en inox type Cubica 10

- matière première: inox AISI 304

- fixation: 2 x M4

- par pièce

N° de com.	Finition	E	L	H	h	L	
016086	noir mat	96 mm	106 mm	35 mm	25 mm	10 mm	1
016087	noir mat	128 mm	138 mm	35 mm	25 mm	10 mm	1
016088	noir mat	160 mm	170 mm	35 mm	25 mm	10 mm	1
016089	noir mat	192 mm	202 mm	35 mm	25 mm	10 mm	1
016090	noir mat	285 mm	295 mm	35 mm	25 mm	10 mm	1



Bouton en inox type Cubica 10

- matière première: inox AISI 304

- fixation: 1 x M4

- par pièce

N° de com.	Finition			H	h	-	
016091	noir mat	12 mm	12 mm	25 mm	-	-	1

POIGNÉES EN DEMI-CERCLE EN INOX

**Poignée en demi-cercle en inox type I0003**

- fixation: 2 x M4

- par pièce

N° de com.	Finition	E	L	H	h	L	
058207	inox brossée	96 mm	115 mm	32 mm	22 mm	10 mm	1
058208	inox brossée	128 mm	152 mm	32 mm	22 mm	10 mm	1
058209	inox brossée	160 mm	187 mm	32 mm	22 mm	10 mm	1
058210	inox brossée	192 mm	224 mm	32 mm	22 mm	10 mm	1

**Poignée en demi-cercle en inox type A10450**

- fixation: 2 x M4

- par pièce

N° de com.	Finition	E	L	H	h	L	
058322	inox brossée	128 mm	150 mm	30 mm	20 mm	10 mm	40
058323	inox brossée	160 mm	183 mm	35 mm	25 mm	10 mm	40
058324	inox brossée	320 mm	368 mm	35 mm	25 mm	10 mm	15

BOUTONS EN INOX

**Bouton en inox type 207.430**

- fixation: 1 x M4

- par pièce

N° de com.	Finition	Ø	Ø	H	h	L	
056853	inox brossée	10 mm	10 mm	20 mm	-	-	1
056854	inox brossée	15 mm	15 mm	30 mm	-	-	1

**Bouton en inox type I2002**

- fixation: 1 x M4

- par pièce

N° de com.	Finition	Ø	Ø	H	h	L	
058228	inox brossée	15 mm	15 mm	22 mm	-	-	1
058229	inox brossée	20 mm	20 mm	28 mm	-	-	1

Bouton en inox type I2001

- fixation: 1 x M4

- par pièce



N° de com.	Finition						
058225	inox brossée	-	25 mm	21 mm	-	-	1

Bouton en inox type D12

- matière première: inox AISI 304

- fixation: 1 x M4

- par pièce



N° de com.	Finition					-	
016092	noir mat	12 mm	12 mm	26 mm	-	-	1

POIGNÉES EN ACIER

POIGNÉES EN ACIER METAKOR

**Poignée courbée en acier type 15.022.35**

- fixation: 2 x M4

- par pièce

N° de com.	Finition	E	L	H	h	L	
058661	nickelée mat	96 mm	104 mm	29 mm	21 mm	8 mm	1

**Poignée en demi-cercle en acier type 78.xxxx.36**

- chromé mat

- fixation: 2 x M4

- par pièce

N° de com.	Finition	E	L	H	h	L	
058667	chromé mat	96 mm	110 mm	28 mm	18 mm	10 mm	1
058668	chromé mat	128 mm	146 mm	28 mm	18 mm	10 mm	1
058671	chromé mat	224 mm	273 mm	28 mm	18 mm	10 mm	1

**Poignée en demi-cercle en acier type 78.xxxx.49**

- nickelé mat

- fixation: 2 x M4

- 96 mm et 128 mm en zamac.

- par pièce

N° de com.	Finition	E	L	H	h	L	
058672	inox look	96 mm	110 mm	28 mm	18 mm	10 mm	1
058673	inox look	128 mm	146 mm	28 mm	18 mm	10 mm	1
058674	inox look	160 mm	194 mm	28 mm	18 mm	10 mm	1
058675	inox look	192 mm	202 mm	28 mm	18 mm	10 mm	1
058676	inox look	224 mm	273 mm	28 mm	18 mm	10 mm	1

POIGNÉES EN ACIER



Poignée en acier type 17812

- fixation: 2 x M4

- par pièce

N° de com.	Finition	E 	L 	H 	h 	L 	
059141	acier bleu	160 mm	190 mm	60 mm	32 mm	20 mm	10
059142	acier bleu	320 mm	350 mm	60 mm	32 mm	20 mm	10



Poignée en acier type 8534260

- fixation: 2 x M4

- par pièce

N° de com.	Finition	E 	L 	H 	h 	L 	
060905	noir mat laqué	160 mm	182 mm	38 mm	28 mm	10 mm	1
060906	noir mat laqué	320 mm	342 mm	38 mm	28 mm	10 mm	1
060907	noir mat laqué	512 mm	534 mm	38 mm	28 mm	10 mm	1







POIGNÉES ET ACCESSOIRES EN LAITON

POIGNÉES EN LAITON OMP



Poignée en laiton type 451







- bronze antique
- fixation: 2 x M4
- par pièce

N° de com.	Finition	 E	 L	 H	 h	 L	
056810	bronze antique	64 mm	100 mm	26 mm	20 mm	-	20
056813	bronze antique	96 mm	145 mm	34 mm	23 mm	-	20



Poignée en laiton type 451







- nickelée
- fixation: 2 x M4
- par pièce

N° de com.	Finition	 E	 L	 H	 h	 L	
056811	nickelée mat	64 mm	100 mm	26 mm	20 mm	-	20
056814	nickelée mat	96 mm	145 mm	34 mm	23 mm	-	20



Poignée en laiton type 451

- antique
- fixation: 2 x M4
- par pièce

N° de com.	Finition	 E	 L	 H	 h	 L	
058532	antique	64 mm	100 mm	26 mm	20 mm	-	20
058533	antique	96 mm	145 mm	34 mm	23 mm	-	20



Cuvette en laiton à appliquer type 454

- fixation: 2 x M4

- par pièce

N° de com.	Finition	E	L	H	h	L	
058530	antique (1)	64 mm	90 mm	40 mm	26 mm	-	20
056816	bronze antique (2)	64 mm	90 mm	40 mm	26 mm	-	20
058531	chromé (3)	64 mm	90 mm	40 mm	26 mm	-	20
056817	nickelée mat (4)	64 mm	90 mm	40 mm	26 mm	-	20



Poignée à encastrer en laiton type 598

- mesures d'enc.: Largeur:31 x Profondeur:10 mm

entraxe 96: Longueur:102 mm

entraxe 128: Longueur:135 mm

- nickelé mat

- par pièce

N° de com.	Finition	E	L	H	h	L	
055352	nickelée mat	96 mm	110 mm	12 mm	10 mm	40 mm	20
055355	nickelée mat	128 mm	140 mm	12 mm	10 mm	40 mm	20



Poignée à encastrer en laiton type 595

- mesures d'encastrement:

diamètre 30: diam. de perçage:26 x Prof.:10 mm

diamètre 40: diam. de perçage:35 x Prof.:10 mm

diamètre 50: diam. de perçage:40 x Prof.:10 mm

- nickelée mat

- par pièce

N° de com.	Finition	E	L	H	h	L	
053370	nickelée mat	26 mm	30 mm	12 mm	10 mm	-	40
053367	nickelée mat	35 mm	40 mm	12 mm	10 mm	-	40
053364	nickelée mat	40 mm	50 mm	12 mm	10 mm	-	40

BOUTONS EN LAITON OMP



Bouton en laiton type 153R

- chromé
- fixation: 1 x M4

- par pièce

N° de com.	Finition						
056021	nickelée brillant	21 mm	21 mm	27 mm	-	-	48



Bouton en laiton type 153

- nickelé
- fixation: 1 x M4

- par pièce

N° de com.	Finition						
052968	nickelée mat	12 mm	12 mm	19 mm	-	-	48
052965	nickelée mat	15 mm	15 mm	22 mm	-	-	48
052962	nickelée mat	18 mm	18 mm	25 mm	-	-	48
052959	nickelée mat	21 mm	21 mm	27 mm	-	-	48



Bouton en laiton type 165

- fixation: 1 x M4

- par pièce

N° de com.	Finition						
056029	nickelée poli	24 mm	25 mm	33 mm	-	-	48
056081	nickelée mat	24 mm	25 mm	33 mm	-	-	48
056645	nickelée mat	29 mm	30 mm	39 mm	-	-	48



Bouton en laiton type 105

- fixation: 1 x M4

- par pièce

N° de com.	Finition						
056124	nickelée mat	13 mm	30 mm	33 mm	-	-	48



Bouton en laiton type 100

- fixation: 1 x M4

- par pièce

N° de com.	Finition						
052098	laiton polie	19 mm	31 mm	28 mm	-	-	48



Bouton en laiton type 158

- bronze antique
- fixation: 1 x M4

- par pièce

N° de com.	Finition						
055221	bronze antique	25 mm	25 mm	24 mm	-	-	48
055219	bronze antique	30 mm	30 mm	29 mm	-	-	48



Bouton en laiton type 158

- poli
- fixation: 1 x M4

- par pièce

N° de com.	Finition						
055220	laiton polie	25 mm	25 mm	24 mm	-	-	48
055218	laiton polie	30 mm	30 mm	29 mm	-	-	48
055216	laiton polie	35 mm	35 mm	33 mm	-	-	24



Bouton en laiton type 102

- bronze antique
- fixation: 1 x M4

- par pièce

N° de com.	Finition						
054208	bronze antique	19 mm	30 mm	28 mm	-	-	48



Bouton en laiton type 161

- bronze antique
- fixation: 1 x M4

- par pièce

N° de com.	Finition						
053010	bronze antique	20 mm	26 mm	23 mm	-	-	48
053008	bronze antique	26 mm	32 mm	26 mm	-	-	48
053006	bronze antique	30 mm	40 mm	30 mm	-	-	24



Bouton en laiton type 160

- poli
- fixation: 1 x M4

- par pièce

N° de com.	Finition						
052990	laiton polie	26 mm	32 mm	23 mm	-	-	48



Bouton en laiton type 160

- nickelé
- fixation: 1 x M4
- par pièce

N° de com.	Finition						
052995	nickelée mat	20 mm	26 mm	20 mm	-	-	48
052992	nickelée mat	26 mm	32 mm	23 mm	-	-	48



Bouton en laiton type 164

- bronze antique
- fixation: 1 x M4
- par pièce

N° de com.	Finition						
053028	bronze antique	18 mm	30 mm	25 mm	-	-	48
053026	bronze antique	21 mm	35 mm	25 mm	-	-	24

POIGNÉES ET BOUTONS EN LAITON



Bouton en laiton type Petra

- matière première: laiton
- fixation: 1 x M4
- par pièce

N° de com.	Finition						
016098	noir mat	17 mm	47 mm	35 mm	22 mm	17 mm	1



Poignée en laiton type Petra

- matière première: laiton
- fixation: 2 x M4
- par pièce







N° de com.	Finition						
016094	noir mat	96 mm	120 mm	35 mm	22 mm	9 mm	1
016095	noir mat	128 mm	152 mm	35 mm	22 mm	9 mm	1
016096	noir mat	160 mm	184 mm	35 mm	22 mm	9 mm	1
016097	noir mat	224 mm	248 mm	35 mm	22 mm	9 mm	1



Bouton en laiton type Olina

- matière première: laiton
- fixation: 1 x M4

- par pièce







N° de com.	Finition						
016093	noir mat	17 mm	39 mm	37 mm	23 mm	13 mm	1



Cuvette en laiton type Modern

- matière première: laiton
- vis inclus

- par pièce







N° de com.	Finition						
016099	noir mat	63 mm	69 mm	33 mm	23 mm	14 mm	1



Cuvette en laiton type Droite

- matière première: laiton
- vis inclus

- par pièce

N° de com.	Finition						
016100	noir mat	90 mm	103 mm	42 mm	28 mm	21 mm	1

POIGNÉES ET BOUTONS EN ZAMAC

POIGNÉES ET BOUTONS EN ZAMAC METAKOR: MODERN

**Poignée en zamac type Recife**

- fixation: 2 x M4

- par pièce

N° de com.	Finition	E	L	H	h	L	
059511	nickelée mat	160 mm	169 mm	28 mm	19 mm	20 mm	25
059512	nickelée mat	224 mm	233 mm	28 mm	19 mm	20 mm	25
059513	nickelée mat	320 mm	329 mm	28 mm	19 mm	20 mm	25

**Poignée en zamac type Rio**

- fixation: 2 x M4

- par pièce

N° de com.	Finition	E	L	H	h	L	
059514	nickelée brillant	160 mm	178 mm	39 mm	25 mm	13 mm	25
059515	nickelée brillant	256 mm	274 mm	39 mm	25 mm	13 mm	25

**Poignée en zamac type Pronto**

- fixation: 2 x M4

- noir mat: RAL9005

- par pièce

N° de com.	Finition	E	L	H	h	L	
059525	nickelée mat	128 mm	134 mm	30 mm	27 mm	10 mm	25
059524	noir mat	128 mm	134 mm	30 mm	27 mm	10 mm	25
059527	nickelée mat	160 mm	166 mm	30 mm	27 mm	10 mm	25
059526	noir mat	160 mm	166 mm	30 mm	27 mm	10 mm	25



Poignée en zamac type Stretch

- fixation: 2 x M4
- noir mat: RAL9005

- par pièce

N° de com.	Finition	E	L	H	h	L	
059990	inox look	96 mm	104 mm	28 mm	19 mm	8 mm	25
059989	noir mat	96 mm	104 mm	28 mm	19 mm	8 mm	25
059519	inox look	160 mm	168 mm	28 mm	19 mm	8 mm	25
059518	noir mat	160 mm	168 mm	28 mm	19 mm	8 mm	25
059992	inox look	224 mm	232 mm	28 mm	19 mm	8 mm	25
059991	noir mat	224 mm	232 mm	28 mm	19 mm	8 mm	25
059521	inox look	320 mm	328 mm	28 mm	19 mm	8 mm	25
059520	noir mat	320 mm	328 mm	28 mm	19 mm	8 mm	25



Poignée en zamac type Scoop

- fixation: 2 x M4

- par pièce

N° de com.	Finition	E	L	H	h	L	
059533	nickelée mat	160 mm	180 mm	26 mm	19 mm	15 mm	25
059987	noir antique	160 mm	180 mm	26 mm	19 mm	15 mm	25
059534	nickelée mat	320 mm	340 mm	26 mm	19 mm	15 mm	25
059988	noir antique	320 mm	340 mm	26 mm	19 mm	15 mm	25



Poignée en zamac type Cubic

- fixation: 2 x M4

- par pièce

N° de com.	Finition	E	L	H	h	L	
059516	nickelée mat	160 mm	180 mm	33 mm	23 mm	7 mm	25
059517	nickelée mat	192 mm	212 mm	33 mm	23 mm	7 mm	25

**Poignée en zamac type Treme**

- fixation: 2 x M4

- par pièce

N° de com.	Finition	E	L	H	h	L	
059531	nickelée mat	32 mm	56 mm	20 mm	-	36 mm	25
059530	nickelée mat	160 mm	200 mm	20 mm	-	36 mm	25

**Poignée en zamac type Phantom**

- fixation: 2 x M4

- par pièce

N° de com.	Finition	E	L	H	h	L	
058651	chromé mat	128 mm	145 mm	35 mm	14 mm	10 mm	1
058653	chromé mat	192 mm	208 mm	35 mm	14 mm	10 mm	1
058652	inox look	128 mm	145 mm	35 mm	14 mm	10 mm	1
058654	inox look	192 mm	208 mm	35 mm	14 mm	10 mm	1

**Poignée en demi-cercle en zamac type Bravo**

- fixation: 2 x M4

- par pièce

N° de com.	Finition	E	L	H	h	L	
058655	chromé mat	128 mm	142 mm	25 mm	17 mm	14 mm	1

**Bouton en zamac type 10122**

- fixation: 1 x M4

- par pièce

N° de com.	Finition	Ø	Ø	H	h	L	
058701	Inox look	20 mm	20 mm	28 mm	-	-	1
058700	chromé mat	20 mm	20 mm	28 mm	-	-	1



Bouton en zamac type Beluga

- fixation: 2 x M4

- par pièce

N° de com.	Finition	E	L	H	h	L	
058697	inox look	16 mm	24 mm	30 mm	25 mm	42 mm	1



Poignée en zamac type Swoosh

- fixation: 2 x M4

- par pièce

N° de com.	Finition	E	L	H	h	L	
059535	nickelée mat	160 mm	200 mm	30 mm	20 mm	11 mm	25
059536	nickelée mat	320 mm	360 mm	32 mm	21 mm	11 mm	25



Poignée en zamac type Genova

- fixation: 2 x M4

- par pièce

N° de com.	Finition	E	L	H	h	L	
059522	nickelée brillant	160 mm	226 mm	31 mm	20 mm	20 mm	25
059523	nickelée brillant	224 mm	290 mm	31 mm	20 mm	20 mm	25



Poignée en zamac type Toronto

- fixation: 2 x M4

- noir mat: RAL9005

- par pièce

N° de com.	Finition	E	L	H	h	L	
059529	nickelée brillant	96 mm	120 mm	26 mm	21 mm	30 mm	25
059528	noir mat	96 mm	120 mm	26 mm	21 mm	30 mm	25

POIGNÉES EN ZAMAC METAKOR: AUTHENTIC

**Poignée en zamac type Derby**

- fixation: 2 x M4

- par pièce

N° de com.	Finition	E	L	H	h	L	
059500	fer vieilli mat	128 mm	169 mm	26 mm	20 mm	26 mm	25
059499	acier noir mat	128 mm	169 mm	26 mm	20 mm	26 mm	25

**Poignée en zamac type Sulky**

- fixation: 2 x M4

- par pièce

N° de com.	Finition	E	L	H	h	L	
059502	fer vieilli mat	128 mm	154 mm	34 mm	23 mm	26 mm	25
059501	acier noir mat	128 mm	154 mm	34 mm	23 mm	26 mm	25

**Poignée en zamac type Halti**

- fixation: 2 x M4

- par pièce

N° de com.	Finition	E	L	H	h	L	
059509	acier noir mat	128 mm	158 mm	31 mm	27 mm	27 mm	25

**Poignée en zamac type Castle**

- fixation: 2 x M4

- par pièce

N° de com.	Finition	E	L	H	h	L	
059510	acier noir mat	160 mm	183 mm	36 mm	33 mm	28 mm	25



Poignée en zamac type Kentucky

- fixation: 2 x M4

- par pièce

N° de com.	Finition	E	L	H	h	L	
059504	fer vieilli mat	160 mm	180 mm	25 mm	20 mm	25 mm	25
059503	acier noir mat	160 mm	180 mm	25 mm	20 mm	25 mm	25



Poignée en zamac type Telford

- fixation: 2 x M4

- par pièce

N° de com.	Finition	E	L	H	h	L	
059506	fer vieilli mat	160 mm	180 mm	30 mm	20 mm	10 mm	25
059505	acier noir mat	160 mm	180 mm	30 mm	20 mm	10 mm	25
059508	fer vieilli mat	224 mm	244 mm	30 mm	20 mm	10 mm	25
059507	acier noir mat	224 mm	244 mm	30 mm	20 mm	10 mm	25



Poignée en zamac type Linea

- fixation: 2 x M4

- par pièce







N° de com.	Finition	E	L	H	h	L	
058956	fer vieux	96 mm	140 mm	22 mm	-	28 mm	100

POIGNÉES ET BOUTONS EN ZAMAC METAKOR: TRADITIONAL

**Poignée en zamac type 70.1959**

- fixation: 2 x M4







- par pièce

N° de com.	Finition	 E	 L	 H	 h	 L	
058690	bronze	64 mm	93 mm	20 mm	16 mm	28 mm	1
058689	inox look	64 mm	93 mm	20 mm	16 mm	28 mm	1

**Poignée en zamac type Big Marcos**

- fixation: 1 x M4

- par pièce

N° de com.	Finition			 H	 h		
058952	acier vieux	-	24 mm	28 mm	-	24 mm	100
058951	acier noir	-	24 mm	28 mm	-	24 mm	100

POIGNÉES ET BOUTONS EN ZAMAC MITAL

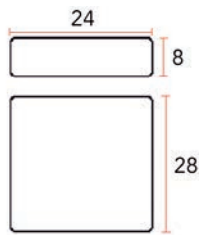

Bouton en zamac type 120

- fixation: 1 x M4

- par pièce

N° de com.	Finition	-	Emballage
059537	nickelée mat	-	25

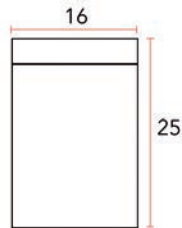

Bouton en zamac type 123

- fixation: 1 x M4

- par pièce

N° de com.	Finition	-	Emballage
059538	acier mat	-	25



Bouton en zamac type 130

- fixation: 1 x M4

- par pièce

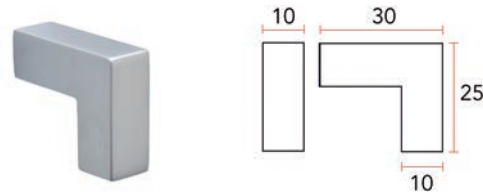

N° de com.	Finition	-	Emballage
059540	nickelée mat	-	25



Bouton en zamac type 435

- fixation: 1 x M4

- par pièce

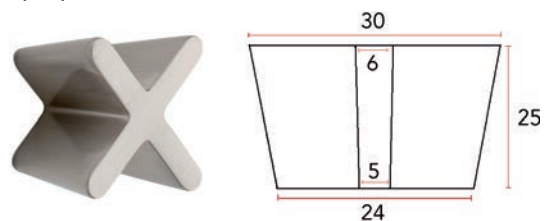

N° de com.	Finition	-	Emballage
059542	nickelée mat	-	25

**Poignée en zamac type 3405**

- fixation: 2 x M4

- par pièce

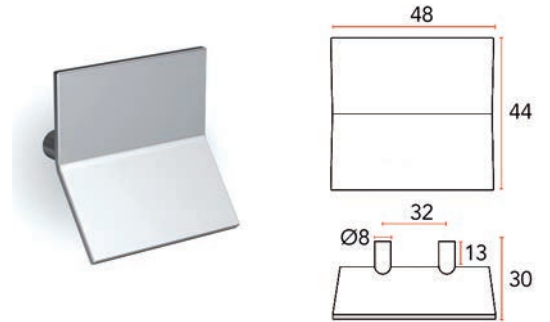

N° de com.	Finition		Emballage
059546	nickelée mat	-	25

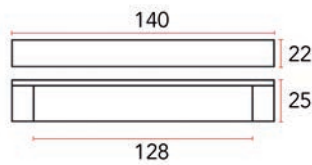
**Poignée en zamac type 3125**

- fixation: 2 x M4

- par pièce

N° de com.	Finition		Emballage
059544	nickelée mat	-	25

**Poignée en zamac type 3600**

- par pièce

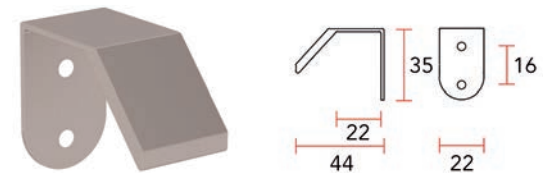

N° de com.	Finition		Emballage
059547	nickelée mat	-	25

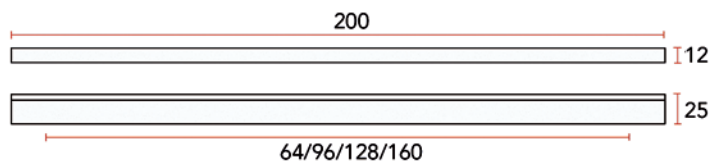
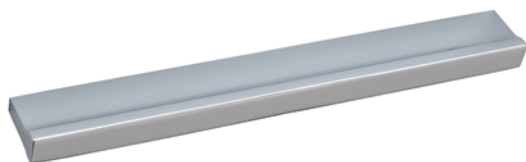

Poignée en zamac type 3990

- fixation: 2 x M4
- adapté pour entraxe 64, 96, 128 et 160 mm
- par pièce

N° de com.	Finition	-	Emballage
059548	nickelée mat	-	25

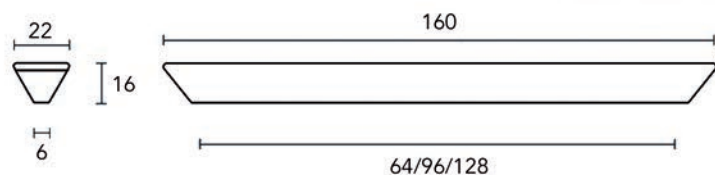
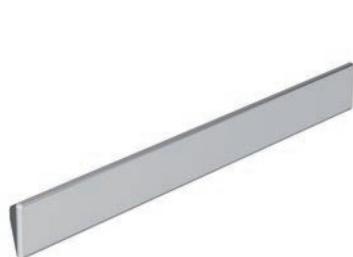

Poignée en zamac type 3320

- fixation: 2 x M4
- adapté pour entraxe 64, 96 et 128 mm
- par pièce

N° de com.	Finition	-	Emballage
059545	nickelée mat	-	25

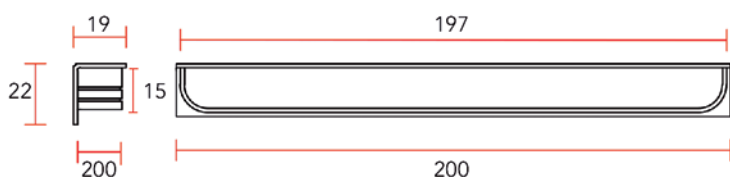

Cuvette en zamac type MA20

- par pièce

N° de com.	Finition	-	Emballage
059550	nickelée mat	-	25

**Cuvette en zamac type MA10**

- fixation: 1 x M4

- par pièce

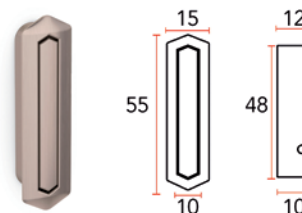

N° de com.	Finition	-	Emballage
059549	nickelée mat	-	25

POIGNÉES ET BOUTONS EN ZAMAC ESTAMP



Cuvette en zamac type 353x

- profondeur d'encastrement: 11 mm

- par pièce

N° de com.	Finition	E	L	H	h	L	
059043	chromé mat	35 mm	40 mm	13 mm	10 mm	26 mm	25
059042	chromé mat	45 mm	49 mm	13 mm	10 mm	31 mm	25
059041	chromé mat	60 mm	65 mm	13 mm	10 mm	43 mm	25
059040	chromé mat	70 mm	75 mm	13 mm	10 mm	53 mm	25
059046	inox look	45 mm	49 mm	13 mm	10 mm	31 mm	25



Cuvette en zamac type 3510/3511

- profondeur d'encastrement: 11 mm

- par pièce

N° de com.	Finition	E	L	H	h	L	
058819	chromé	35 mm	40 mm	13 mm	11 mm	40 mm	25
058820	chromé mat	35 mm	40 mm	13 mm	11 mm	40 mm	25
058818	inox look	35 mm	40 mm	13 mm	11 mm	40 mm	25
059478	blanc	35 mm	40 mm	13 mm	11 mm	40 mm	25
059562	blanc mat	35 mm	40 mm	13 mm	11 mm	40 mm	25
059563	noir mat	35 mm	40 mm	13 mm	11 mm	40 mm	25
058816	chromé	45 mm	49 mm	13 mm	11 mm	49 mm	25
058817	chromé mat	45 mm	49 mm	13 mm	11 mm	49 mm	25
058815	inox look	45 mm	49 mm	13 mm	11 mm	49 mm	25
059564	blanc mat	45 mm	49 mm	13 mm	11 mm	49 mm	25
059565	noir mat	45 mm	49 mm	13 mm	11 mm	49 mm	25

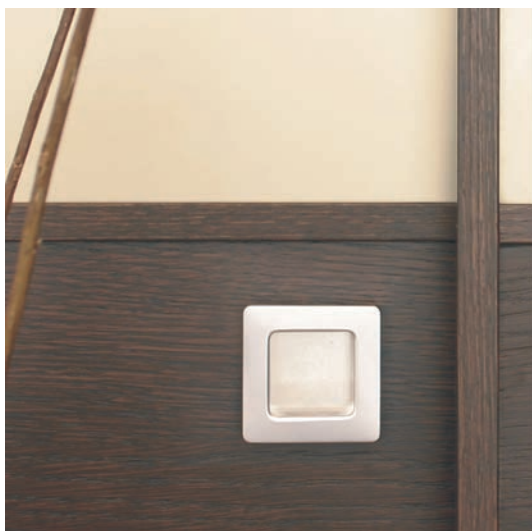

Cuvette en zamac type 3560/3561
- profondeur d'encastrement: 11 mm
- par pièce

N° de com.	Finition	E	L	H	h	L	
058825	chromé	35 mm	39 mm	13 mm	11 mm	39 mm	25
058826	chromé mat	35 mm	39 mm	13 mm	11 mm	39 mm	25
058824	inox look	35 mm	39 mm	13 mm	11 mm	39 mm	25
058822	chromé	45 mm	50 mm	13 mm	11 mm	50 mm	25
058823	chromé mat	45 mm	50 mm	13 mm	11 mm	50 mm	25
058821	inox look	45 mm	50 mm	13 mm	11 mm	50 mm	25









Cuvette en zamac type 3710
- par pièce

N° de com.	Finition	E	L	H	h	L	
058757	chromé	76 x 76 mm	80 mm	14 mm	-	80 mm	25
058758	chromé mat	76 x 76 mm	80 mm	14 mm	-	80 mm	25
058756	inox look	76 x 76 mm	80 mm	14 mm	-	80 mm	25



Cuvette en zamac type 3720

- par pièce







N° de com.	Finition	 E	 L	 H	 h	 L	
058743	chromé mat	160 mm	180 mm	16 mm	-	50 mm	10
058742	inox look	160 mm	180 mm	16 mm	-	50 mm	10



Cuvette en zamac type 3702/3703

- profondeur d'encastrement: 11 mm

- par pièce

N° de com.	Finition	 E	 L	 H	 h	 L	
058831	chromé	78 mm	83 mm	13 mm	11 mm	36 mm	25
058832	chromé mat	78 mm	83 mm	13 mm	11 mm	36 mm	25
058830	inox look	78 mm	83 mm	13 mm	11 mm	36 mm	25
058828	chromé	110 mm	113 mm	14 mm	12 mm	42 mm	25
058829	chromé mat	110 mm	113 mm	14 mm	12 mm	42 mm	25
058827	inox look	110 mm	113 mm	14 mm	12 mm	42 mm	25

**Cuvette en zamac type 3541/3542**

- par pièce

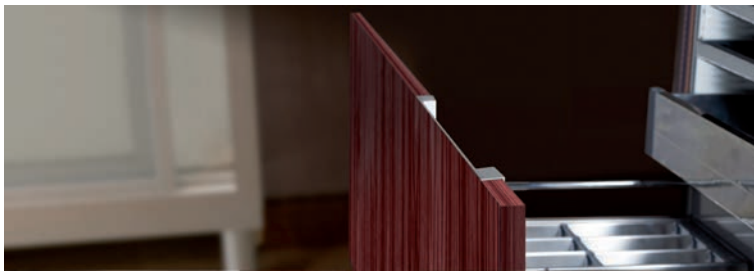

N° de com.	Finition	E	L	H	L	L	
059049	inox look	145 mm	150 mm	10,7 mm	20 mm	25 mm	25
059048	inox look	235 mm	240 mm	10,7 mm	20 mm	25 mm	25

**Cuvette en aluminium type 3730**

- montage à l'intérieur de la porte
 - profondeur d'encastrement: 16 mm
 - fixation: 2 x M4

- par pièce



N° de com.	Finition	E	L	H	d	D	
058834	aluminium	170 mm	180 mm	25 mm	13 mm	18 mm	25

**Cuvette en aluminium type 3740**

- fixation: 2 x M4

- par pièce

N° de com.	Finition	E	L	H	d	D	
058835	aluminium	160 mm	180 mm	45 mm	12 mm	17 mm	20



Poignée en zamac type 7661/7662/7663

- poignée type 7663: entraxe 32 mm
- poignée type 7662: entraxe 96 mm
- poignée type 7661: entraxe 192 mm

- par pièce



N° de com.	Finition	E	L	H	d	P	
058754	chromé	32 mm	71 mm	24 mm	2 mm	44 mm	25
058755	chromé mat	32 mm	71 mm	24 mm	2 mm	44 mm	25
058753	inox look	32 mm	71 mm	24 mm	2 mm	44 mm	25
059556	blanc mat	32 mm	71 mm	24 mm	2 mm	44 mm	25
059555	noir mat	32 mm	71 mm	24 mm	2 mm	44 mm	25
058751	chromé	96 mm	135 mm	24 mm	2 mm	44 mm	25
058752	chromé mat	96 mm	135 mm	24 mm	2 mm	44 mm	25
058750	inox look	96 mm	135 mm	24 mm	2 mm	44 mm	25
059554	blanc mat	96 mm	135 mm	24 mm	2 mm	44 mm	25
059553	noir mat	96 mm	135 mm	24 mm	2 mm	44 mm	25
058748	chromé	192 mm	231 mm	24 mm	2 mm	44 mm	20
058749	chromé mat	192 mm	231 mm	24 mm	2 mm	44 mm	20
058747	inox look	192 mm	231 mm	24 mm	2 mm	44 mm	20
059552	blanc mat	192 mm	231 mm	24 mm	2 mm	44 mm	20
059551	noir mat	192 mm	231 mm	24 mm	2 mm	44 mm	20



Poignée en zamac type 6831/6832

- fixation: 2 x M4

- par pièce



N° de com.	Finition	E	L	H	h	L	
060396	or mat	128 mm	149 mm	20 mm	18 mm	31 mm	25
060405	graphite	128 mm	149 mm	20 mm	18 mm	31 mm	25
060293	inox look	128 mm	149 mm	20 mm	18 mm	31 mm	25
060292	noir mat	128 mm	149 mm	20 mm	18 mm	31 mm	25
060395	or mat	192 mm	213 mm	20 mm	18 mm	31 mm	25
060404	graphite	192 mm	213 mm	20 mm	18 mm	31 mm	25
060291	inox look	192 mm	213 mm	20 mm	18 mm	31 mm	25
060290	noir mat	192 mm	213 mm	20 mm	18 mm	31 mm	25

**Poignée en zamac type Arch**

- fixation: 2 x M4

- par pièce



N° de com.	Finition	E	L	H	h	L	
059416	chromé mat	128 mm	240 mm	18 mm	16 mm	20 mm	25
059415	inox look	128 mm	240 mm	18 mm	16 mm	20 mm	25
059414	chromé mat	192 mm	320 mm	18 mm	16 mm	20 mm	25
059413	inox look	192 mm	320 mm	18 mm	16 mm	20 mm	25

**Poignée en zamac type Fluid**

- fixation: 2 x M4

- par pièce



N° de com.	Finition	E	L	H	h	L	
059497	inox look	192/224 mm	236 mm	29 mm	-	13 mm	25
059498	blanc mat	192/224 mm	236 mm	29 mm	-	13 mm	25
059496	noir mat	192/224 mm	236 mm	29 mm	-	13 mm	25
059494	inox look	288/320 mm	363 mm	34 mm	-	13 mm	15
059495	blanc mat	288/320 mm	363 mm	34 mm	-	13 mm	15
059493	noir mat	288/320 mm	363 mm	34 mm	-	13 mm	15



Poignée en zamac type 7150

- fixation: 2 x M4

- par pièce

N° de com.	Finition	E	L	H	h	L	
058864	chromé	96 mm	152 mm	27 mm	21 mm	20 mm	25
058865	chromé mat	96 mm	152 mm	27 mm	21 mm	20 mm	25
058863	inox look	96 mm	152 mm	27 mm	21 mm	20 mm	25



Poignée en zamac type Fuji 681

- fixation: 2 x M4

- par pièce



N° de com.	Finition	E	L	H	h	L	
059487	chromé	160 mm	230 mm	32 mm	-	20 mm	25
059488	chromé mat	160 mm	230 mm	32 mm	-	20 mm	25
060394	or mat	160 mm	230 mm	32 mm	26 mm	20 mm	25
060403	graphite	160 mm	230 mm	32 mm	26 mm	20 mm	25
059486	inox look	160 mm	230 mm	32 mm	-	20 mm	25
059484	chromé	224 mm	320 mm	32 mm	-	20 mm	20
059485	chromé mat	224 mm	320 mm	32 mm	-	20 mm	20
060393	or mat	224 mm	320 mm	32 mm	26 mm	20 mm	20
060402	graphite	224 mm	320 mm	32 mm	26 mm	20 mm	20
059483	inox look	224 mm	320 mm	32 mm	-	20 mm	20

**Poignée en zamac type 7861/7862**

- fixation: 2 x M4

- par pièce

N° de com.	Finition	E	L	H	h	L	
059444	blanc brillant	96 mm	124 mm	29 mm	20 mm	9 mm	25
059445	noir brillant	96 mm	124 mm	29 mm	20 mm	9 mm	25
059442	blanc brillant	128 mm	164 mm	29 mm	20 mm	10 mm	25
059443	noir brillant	128 mm	164 mm	29 mm	20 mm	10 mm	25

**Poignée en zamac type 8010**

- fixation: 1 x M4

- par pièce

N° de com.	Finition			H	h	L	
059446	blanc brillant	12 mm	12 mm	28 mm	-	12 mm	25
059447	noir brillant	12 mm	12 mm	28 mm	-	12 mm	25

**Poignée en zamac type Align**

- fixation: 2 x M4

- par pièce

N° de com.	Finition	E	L	H	h	L	
059471	chromé mat	128 mm	157 mm	20 mm	15 mm	9 mm	25
059470	inox look	128 mm	157 mm	20 mm	15 mm	9 mm	25
059473	blanc mat	128 mm	157 mm	20 mm	15 mm	9 mm	200
059472	noir mat	128 mm	157 mm	20 mm	15 mm	9 mm	200
059467	chromé mat	192 mm	208 mm	20 mm	15 mm	9 mm	25
059466	inox look	192 mm	208 mm	20 mm	15 mm	9 mm	25
059469	blanc mat	192 mm	208 mm	20 mm	15 mm	9 mm	200
059468	noir mat	192 mm	208 mm	20 mm	15 mm	9 mm	200
059463	chromé mat	224 mm	252 mm	20 mm	15 mm	9 mm	25
059462	inox look	224 mm	252 mm	20 mm	15 mm	9 mm	25
059465	blanc mat	224 mm	252 mm	20 mm	15 mm	9 mm	200
059464	noir mat	224 mm	252 mm	20 mm	15 mm	9 mm	200



Bouton en zamac type Align

- fixation: 1 x M4

- par pièce

N° de com.	Finition						
059475	chromé mat	15 mm	15 mm	29 mm	-	-	25



Poignée en zamac type 7461/7462

- fixation: 2 x M4

- par pièce



N° de com.	Finition						
058870	chromé	128 mm	161 mm	24 mm	20 mm	19 mm	20
058871	chromé mat	128 mm	161 mm	24 mm	20 mm	19 mm	20
058869	inox look	128 mm	161 mm	24 mm	20 mm	19 mm	20
058867	chromé	160 mm	197 mm	24 mm	20 mm	21 mm	20
058868	chromé mat	160 mm	197 mm	24 mm	20 mm	21 mm	20
058866	inox look	160 mm	197 mm	24 mm	20 mm	21 mm	20



Poignée en zamac type i-spazio

- fixation: 2 x M4

- par pièce

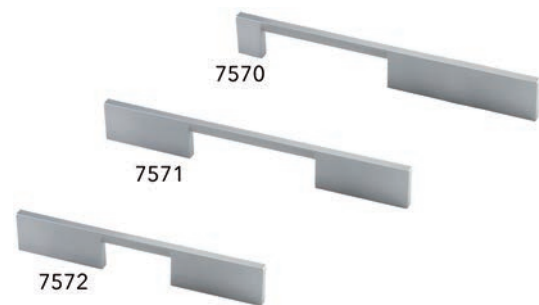

N° de com.	Finition						
058882	type 7572 - inox look	128 mm	200 mm	32 mm	22 mm	8 mm	25
058879	type 7571 - inox look	192 mm	260 mm	32 mm	22 mm	8 mm	20
059418	type 7570 - inox look	192 mm	260 mm	32 mm	22 mm	8 mm	20

**Poignée en zamac type Cubic**

- fixation: 2 x M4

- par pièce



N° de com.	Finition	E	L	H	h	L	
059431	chromé mat	32 mm	55 mm	20 mm	-	10 mm	25
059430	inox look	32 mm	55 mm	20 mm	-	10 mm	25
059429	chromé mat	64 mm	85 mm	20 mm	-	11 mm	25
059428	inox look	64 mm	85 mm	20 mm	-	11 mm	25
059427	chromé mat	96 mm	115 mm	20 mm	-	12 mm	25
059426	inox look	96 mm	115 mm	20 mm	-	12 mm	25

**Poignée en zamac type 7291/7292**

- fixation: 2 x M4

- par pièce

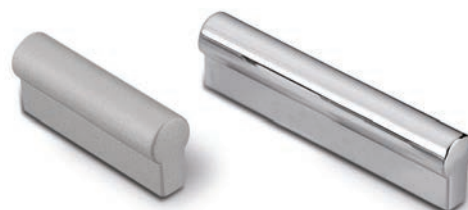

N° de com.	Finition	E	L	H	h	L	
059441	chromé	32 mm	48 mm	20 mm	-	12 mm	25
059440	inox look	32 mm	48 mm	20 mm	-	12 mm	25
059439	chromé	64 mm	81 mm	20 mm	-	12 mm	25
059438	inox look	64 mm	81 mm	20 mm	-	12 mm	25









Poignée en zamac type Square

- fixation: 2 x M4

- par pièce







N° de com.	Finition						
059437	chromé mat	64 mm	81 mm	29 mm	18 mm	10 mm	25
059436	inox look	64 mm	81 mm	29 mm	18 mm	10 mm	25
059435	chromé mat	96 mm	114 mm	30 mm	18 mm	11 mm	25
059434	inox look	96 mm	114 mm	30 mm	18 mm	11 mm	25
059433	chromé mat	128 mm	146 mm	30 mm	18 mm	12 mm	25
059432	inox look	128 mm	146 mm	30 mm	18 mm	12 mm	25



Bouton en zamac type Square

- fixation: 1 x M4

- par pièce

N° de com.	Finition					-	
059461	chromé mat	8 mm	12 mm	24 mm	-	-	25
059460	inox look	8 mm	12 mm	24 mm	-	-	25









Poignée en zamac type 7531

- fixation: 2 x M4

- par pièce



N° de com.	Finition						
058877	chromé	96 mm	124 mm	30 mm	16 mm	8 mm	25
058878	chromé mat	96 mm	124 mm	30 mm	16 mm	8 mm	25
058876	inox look	96 mm	124 mm	30 mm	16 mm	8 mm	25
058745	chromé	160 mm	188 mm	35 mm	-	9 mm	25
058746	chromé look	160 mm	188 mm	35 mm	-	9 mm	25
058744	inox look	160 mm	188 mm	35 mm	-	9 mm	25

**Poignée en zamac type 7691/7692/7693/7694**

- fixation: 2 x M4

- par pièce



N° de com.	Finition	E	L	H	h	L	
058904	chromé	16 mm	26 mm	26 mm	17 mm	10 mm	25
058903	inox look	16 mm	26 mm	26 mm	17 mm	10 mm	25
058901	chromé	128 mm	137 mm	26 mm	17 mm	10 mm	25
058902	chromé mat	128 mm	137 mm	26 mm	17 mm	10 mm	25
058900	inox look	128 mm	137 mm	26 mm	17 mm	10 mm	25
058899	chromé mat	160 mm	169 mm	26 mm	17 mm	10 mm	25
058897	inox look	160 mm	169 mm	26 mm	17 mm	10 mm	25
058895	chromé	192 mm	200 mm	26 mm	17 mm	10 mm	25
058896	chromé mat	192 mm	200 mm	26 mm	17 mm	10 mm	25
058894	inox look	192 mm	200 mm	26 mm	17 mm	10 mm	25

**Poignée en zamac type****6761/6762/6763/6764/6765**

- fixation: 2 x M4

- par pièce



N° de com.	Finition	E	L	H	h	L	
059164	chromé mat	128 mm	136 mm	28 mm	20 mm	8 mm	25
060392	or mat	128 mm	136 mm	28 mm	20 mm	8 mm	25
060401	graphite	128 mm	136 mm	28 mm	20 mm	8 mm	25
059163	inox look	128 mm	136 mm	28 mm	20 mm	8 mm	25
059162	chromé mat	160 mm	168 mm	28 mm	20 mm	8 mm	25
059161	inox look	160 mm	168 mm	28 mm	20 mm	8 mm	25
059160	chromé mat	192 mm	200 mm	28 mm	20 mm	8 mm	25
060391	or mat	192 mm	200 mm	28 mm	20 mm	8 mm	25
060400	graphite	192 mm	200 mm	28 mm	20 mm	8 mm	25
059159	inox look	192 mm	200 mm	28 mm	20 mm	8 mm	25
059158	chromé mat	256 mm	264 mm	28 mm	20 mm	8 mm	25
059157	inox look	256 mm	264 mm	28 mm	20 mm	8 mm	25
059156	chromé mat	320 mm	328 mm	28 mm	20 mm	8 mm	25
060390	or mat	320 mm	328 mm	28 mm	20 mm	8 mm	25
060399	graphite	320 mm	328 mm	28 mm	20 mm	8 mm	25
059155	inox look	320 mm	328 mm	28 mm	20 mm	8 mm	25









Bouton en zamac type 8102/8103

- fixation: 1 x M4

- par pièce



N° de com.	Finition						
059168	inox look	-	32 x 32 mm	-	-	-	20









Bouton en zamac type 8151

- fixation: 1 x M4

- par pièce









N° de com.	Finition						
060397	or mat	22 x 22 mm	25 x 25 mm	28 mm	-	-	25
060406	graphite	22 x 22 mm	25 x 25 mm	28 mm	-	-	25
058918	inox look	22 x 22 mm	25 x 25 mm	28 mm	-	-	25

**Bouton en zamac type 8152**

- fixation: 1 x M4





- par pièce

N° de com.	Finition						
058921	inox look	13 x 13 mm	15 x 15 mm	24 mm	-	-	25

**Bouton en zamac type Disc 8342**

- fixation: 1 x M4







- par pièce

N° de com.	Finition					
060600	doré mat	28 mm	15 mm	23 mm	19 mm	25
060602	inox look	28 mm	15 mm	23 mm	19 mm	25
060603	blanc mat	28 mm	15 mm	23 mm	19 mm	25
060601	noir mat	28 mm	15 mm	23 mm	19 mm	25

**Bouton en zamac type 8161**

- fixation: 1 x M4

- par pièce

N° de com.	Finition						
060398	or mat	23 mm	25 mm	28 mm	-	-	25
060407	graphite	23 mm	25 mm	28 mm	-	-	25
058924	inox look	23 mm	25 mm	28 mm	-	-	25



Bouton en zamac type 8162

- fixation: 1 x M4

- par pièce

N° de com.	Finition						
058927	inox look	13 mm	15 mm	24 mm	-	-	25



Bouton en zamac type 8171

- fixation: 1 x M4

- par pièce

N° de com.	Finition						
058930	inox look	-	34 mm	28 mm	-	14 mm	25



Bouton en zamac type 8172

- fixation: 1 x M4

- par pièce

N° de com.	Finition						
058933	inox look	-	27 mm	24 mm	-	11 mm	25

POIGNÉES EN ZAMAC EUREKA



Poignée en zamac type 1431

- fixation: 2 x M4

- par pièce

N° de com.	Finition						
058967	inox look/chromé	160 mm	167 mm	29 mm	23 mm	27 mm	25

**Poignée en zamac type 1266**

- fixation: 2 x M4

- par pièce

N° de com.	Finition	E	L	H	h	L	
058964	inox look	128 mm	136 mm	28 mm	20 mm	9 mm	25
058963	chromé brillant	128 mm	136 mm	28 mm	20 mm	9 mm	25

**Poignée en zamac type 1327**

- fixation: 2 x M4

- par pièce

N° de com.	Finition	E	L	H	h	L	
058966	inox look	160 mm	168 mm	28 mm	20 mm	9 mm	25

**Poignée en zamac type 1349**

- fixation: 2 x M4

- trous de fixation à 160 et 192 mm

- par pièce

N° de com.	Finition	E	L	H	h	L	
058973	inox look	160-192 mm	200 mm	28 mm	20 mm	9 mm	25
058972	chromé brillant	160-192 mm	200 mm	28 mm	20 mm	9 mm	25

**Poignée en zamac type 1351**

- fixation: 2 x M4

- par pièce

N° de com.	Finition	E	L	H	h	L	
058975	inox look	320 mm	345 mm	28 mm	20 mm	9 mm	25
058974	chromé brillant	320 mm	345 mm	28 mm	20 mm	9 mm	25

**Poignée en zamac type 1340**

- fixation: 2 x M4

- par pièce

N° de com.	Finition	E	L	H	h	L	
058969	inox look	160 mm	172 mm	34 mm	26 mm	9 mm	25



Poignée en zamac type 1368

- fixation: 2 x M4
- trous de fixation à 160 et 192 mm

- par pièce

N° de com.	Finition	E	L	H	h	L	
058962	inox look	160-192 mm	202 mm	28 mm	23 mm	28 mm	25

POIGNÉES EN ZAMAC

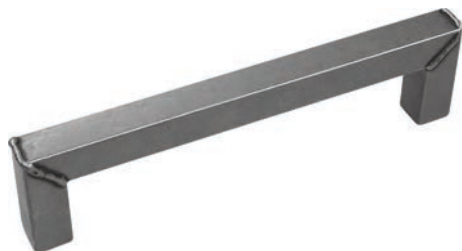

Poignée en zamac type 17811

- fixation: 2 x M4

- par pièce

N° de com.	Finition	E	L	H	h	L	
059140	soudé	160 mm	175 mm	45 mm	30 mm	15 mm	20

BOUTONS ET POIGNÉES EN FER FORGÉ

POIGNÉES ET BOUTONS PURE







Poignée Pure Type PMBU

- fixation: 2 x M4

- par pièce



N° de com.	Finition	 E	 L	 H	 h	
060535	1 - bronze brut	96 mm	154 mm	39 mm	32 mm	1
059972	1 - bronze brut	128 mm	184 mm	41 mm	34 mm	1
060451	1 - bronze brut	224 mm	370 mm	43 mm	36 mm	1
059336	2 - métal brut	96 mm	154 mm	39 mm	32 mm	1
059337	2 - métal brut	128 mm	184 mm	41 mm	34 mm	1
059338	2 - métal brut	224 mm	370 mm	43 mm	36 mm	1
059234	3 - fer vieilli	96 mm	154 mm	39 mm	32 mm	1
058771	3 - fer vieilli	128 mm	184 mm	41 mm	34 mm	1
059236	3 - fer vieilli	224 mm	370 mm	43 mm	36 mm	1

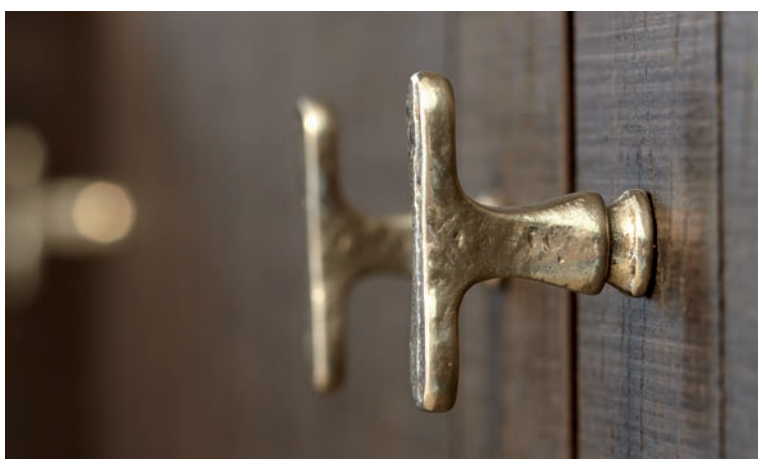





Bouton Pure Type PBU

- fixation: 1 x M4

- par pièce



N° de com.	Finition	 L	 Ø	 H	 h	
060428	1 - bronze brut	37 mm	12 mm	25 mm	21 mm	1
059879	1 - bronze brut	45 mm	16 mm	35 mm	29 mm	1
059861	2 - métal brut	37 mm	12 mm	25 mm	21 mm	1
059335	2 - métal brut	45 mm	16 mm	35 mm	29 mm	1
058763	3 - fer vieilli	37 mm	12 mm	25 mm	21 mm	1
058801	3 - fer vieilli	45 mm	16 mm	35 mm	29 mm	1
058802	4 - bronze blanc	45 mm	16 mm	35 mm	29 mm	1









Poignée Pure Type PMT

- fixation: 2 x M4

- par pièce



N° de com.	Finition						
060593	1 - bronze brut	128 mm	190 mm	37 mm	31 mm	11 mm	1
059348	2 - métal brut	128 mm	190 mm	37 mm	31 mm	11 mm	1
059228	3 - fer vieilli	128 mm	190 mm	37 mm	31 mm	11 mm	1







Bouton Pure type PTT

- fixation: 1 x M4

- par pièce







N° de com.	Finition					
060594	1 - bronze brut	60 mm	10 mm	36 mm	30 mm	1
059347	2 - métal brut	60 mm	10 mm	36 mm	30 mm	1
059206	3 - fer vieilli	60 mm	10 mm	36 mm	30 mm	1



Bouton Pure type PQT

- fixation: 1 x M4

- par pièce

N° de com.	Finition					
060654	1 - bronze brut	50 mm	16 mm	37 mm	25 mm	1
060631	2 - métal brut	50 mm	16 mm	37 mm	25 mm	1
060555	3 - fer vieilli	50 mm	16 mm	37 mm	25 mm	1







Bouton Pure type PCRO

- fixation: 1 x M4

- par pièce



N° de com.	Finition	 L		 H	 h	
060632	1 - bronze brut	38 mm	-	27 mm	-	1
060633	2 - métal brut	38 mm	-	27 mm	-	1
060569	3 - fer vieilli	38 mm	-	27 mm	-	1









Poignée Pure Type PMCRO

- fixation: 2 x M4

- par pièce



N° de com.	Finition	 E	 L	 H	 h	 L	
060634	1 - bronze brut	128 mm	166 mm	27 mm	-	38 mm	1
060635	1 - bronze brut	160 mm	200 mm	27 mm	-	38 mm	1
060636	2 - métal brut	128 mm	166 mm	27 mm	-	38 mm	1
060637	2 - métal brut	160 mm	200 mm	27 mm	-	38 mm	1
060638	3 - fer vieilli	128 mm	166 mm	27 mm	-	38 mm	1
060639	3 - fer vieilli	160 mm	200 mm	27 mm	-	38 mm	1









Poignée Pure Type PMR

- fixation: 2 x M4

- par pièce



N° de com.	Finition	 E	 L	 H	 h	 L	
060640	1 - bronze brut	96 mm	126 mm	38 mm	-	22 mm	1
060388	2 - métal brut	96 mm	126 mm	38 mm	-	22 mm	1
059865	3 - fer vieilli	96 mm	126 mm	38 mm	-	22 mm	1







Bouton Pure Type PT

- fixation: 1 x M4

- par pièce



N° de com.	Finition	 Ø	 Ø	 H	 h	
060619	1 - bronze brut	20 mm	9 mm	27 mm	7 mm	1
059881	1 - bronze brut	25 mm	10 mm	35 mm	10 mm	1
059333	2 - métal brut	20 mm	9 mm	27 mm	7 mm	1
059334	2 - métal brut	25 mm	10 mm	35 mm	10 mm	1
058759	3 - fer vieilli	20 mm	9 mm	27 mm	7 mm	1
058761	3 - fer vieilli	25 mm	10 mm	35 mm	10 mm	1



Bouton Pure type PFL

- fixation: 1 x M4

- par pièce

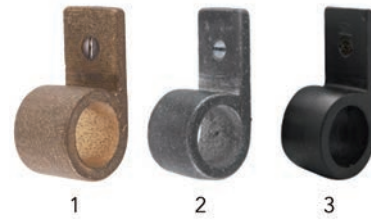

N° de com.	Finition	P	H	L	
060620	1 - bronze brut	27 mm	52 mm	23 mm	1
060604	1 - bronze brut	30 mm	62 mm	24 mm	1
059355	2 - métal brut	27 mm	52 mm	23 mm	1
059356	2 - métal brut	30 mm	62 mm	24 mm	1
059208	3 - fer vieilli	27 mm	52 mm	23 mm	1
059209	3 - fer vieilli	30 mm	62 mm	24 mm	1



Poignée Pure Type PMQ

- fixation: 2 x M4

- par pièce



N° de com.	Finition	E	L	H	h	
059560	1 - bronze brut	96 mm	108 mm	40 mm	28 mm	1
060621	1 - bronze brut	128 mm	140 mm	40 mm	28 mm	1
060590	1 - bronze brut	160 mm	172 mm	40 mm	28 mm	1
059242	1 - bronze brut	224 mm	236 mm	40 mm	28 mm	1
060410	1 - bronze brut	384 mm	396 mm	40 mm	28 mm	1
059243	1 - bronze brut	512 mm	524 mm	40 mm	28 mm	1
059341	2 - métal brut	96 mm	108 mm	40 mm	28 mm	1
059342	2 - métal brut	128 mm	140 mm	40 mm	28 mm	1
059343	2 - métal brut	160 mm	172 mm	40 mm	28 mm	1
059344	2 - métal brut	224 mm	236 mm	40 mm	28 mm	1
059345	2 - métal brut	384 mm	396 mm	40 mm	28 mm	1
059346	2 - métal brut	512 mm	524 mm	40 mm	28 mm	1
058773	3 - fer vieilli	96 mm	108 mm	40 mm	28 mm	1
058775	3 - fer vieilli	128 mm	140 mm	40 mm	28 mm	1
058777	3 - fer vieilli	160 mm	172 mm	40 mm	28 mm	1
059232	3 - fer vieilli	224 mm	236 mm	40 mm	28 mm	1
059224	3 - fer vieilli	384 mm	396 mm	40 mm	28 mm	1
059226	3 - fer vieilli	512 mm	524 mm	40 mm	28 mm	1





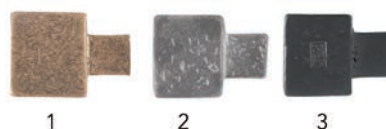

Bouton Pure Type PQ

- fixation: 1 x M4

- par pièce



N° de com.	Finition					
060622	1 - bronze brut	15 mm	9 mm	27 mm	13 mm	1
059862	1 - bronze brut	20 mm	11 mm	33 mm	13 mm	1
059363	1 - bronze brut	25 mm	13 mm	33 mm	13 mm	1
059364	1 - bronze brut	35 mm	-	38 mm	13 mm	1
059365	1 - bronze brut	45 mm	-	49 mm	13 mm	1
059864	2 - métal brut	15 mm	9 mm	27 mm	13 mm	1
059863	2 - métal brut	20 mm	11 mm	33 mm	13 mm	1
059340	2 - métal brut	25 mm	13 mm	33 mm	13 mm	1
059248	2 - métal brut	35 mm	-	38 mm	13 mm	1
060623	2 - métal brut	45 mm	-	49 mm	13 mm	1
058765	3 - fer vieilli	15 mm	9 mm	27 mm	13 mm	1
058767	3 - fer vieilli	20 mm	11 mm	33 mm	13 mm	1
059230	3 - fer vieilli	25 mm	13 mm	33 mm	13 mm	1
059246	3 - fer vieilli	35 mm	-	38 mm	13 mm	1
060624	3 - fer vieilli	45 mm	-	49 mm	13 mm	1





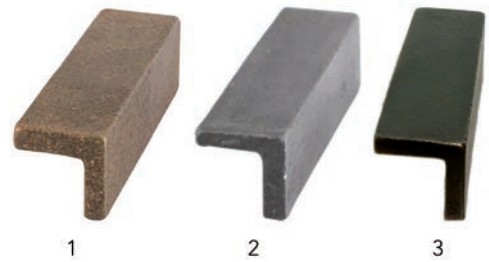

Poignée Pure Type PML

- fixation: 2 x M4
- fixation longueur 700 mm: 3 x M6

- par pièce



N° de com.	Finition	 E	 L	 H	 h	
060625	1 - bronze brut	32 mm	50 mm	27 mm	21 mm	1
060626	1 - bronze brut	64 mm	100 mm	27 mm	21 mm	1
059371	1 - bronze brut	96 mm	150 mm	27 mm	21 mm	1
060627	1 - bronze brut	2 x 250 mm	700 mm	27 mm	21 mm	1
059349	2 - métal brut	32 mm	50 mm	27 mm	21 mm	1
059350	2 - métal brut	64 mm	100 mm	27 mm	21 mm	1
059351	2 - métal brut	96 mm	150 mm	27 mm	21 mm	1
060628	2 - métal brut	2 x 250 mm	700 mm	27 mm	21 mm	1
058779	3 - fer vieilli	32 mm	50 mm	27 mm	21 mm	1
058781	3 - fer vieilli	64 mm	100 mm	27 mm	21 mm	1
058783	3 - fer vieilli	96 mm	150 mm	27 mm	21 mm	1
059101	3 - fer vieilli	2 x 250 mm	700 mm	27 mm	21 mm	1







Poignée Pure Type PMSP

- fixation: 2 x M4

- par pièce



N° de com.	Finition	 E	 L	 H	 h	
060629	1 - bronze brut	32 mm	50 mm	18 mm	15 mm	1
060630	1 - bronze brut	64 mm	100 mm	18 mm	15 mm	1
059352	2 - métal brut	32 mm	50 mm	18 mm	15 mm	1
059353	2 - métal brut	64 mm	100 mm	18 mm	15 mm	1
058785	3 - fer vieilli	32 mm	50 mm	18 mm	15 mm	1
058787	3 - fer vieilli	64 mm	100 mm	18 mm	15 mm	1







Poignée Pure Type PCO

- fixation: 2 x M4

- par pièce



N° de com.	Finition	 E	 L	 H	 h	
060060	1 - bronze brut	64 mm	82 mm	30 mm	25 mm	1
059339	2 - métal brut	64 mm	82 mm	30 mm	25 mm	1
058769	3 - fer vieilli	64 mm	82 mm	30 mm	25 mm	1

ACCESSOIRES PURE PLUS

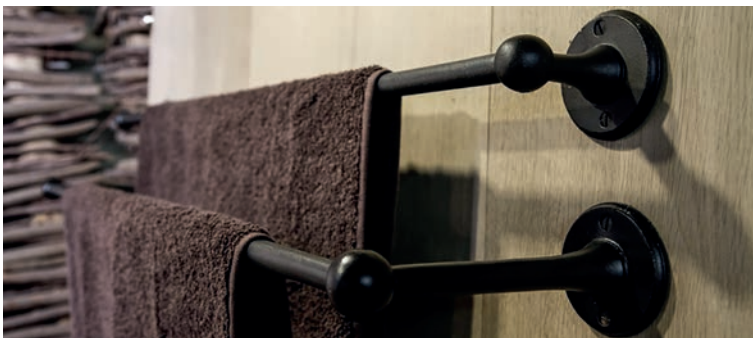

Mains courantes avec supports Pure Plus type PR

- crochets à commander séparément

- par pièce

N° de com.	Finition	Longueur	Diamètre	Hauteur	Emballage
058791	fer vieilli	1000 mm	14 mm	65 mm	1
059869	fer vieilli	1000 mm	14 mm	150 mm	1



Support Pure Plus type PRst

- pour mains courantes type PR

- par pièce



N° de com.	Finition	Hauteur	Emballage
058803	fer vieilli	65 mm	1

**Crochet Pure Plus type PRh**

- pour mains courantes type PR

- par pièce

N° de com.	Finition	Hauteur	Emballage
058793	fer vieilli	52 mm	1

**Portemanteau Pure Plus**

- par pièce

N° de com.	Finition	-	Emballage
058799	fer vieilli	-	1

**Crochet mural Pure Plus type PT-Q**

- par pièce

N° de com.	Finition	Plaque de montage	Profondeur	Emballage
059887	fer vieilli	50 x 50 mm	-	1

**Crochet mural Pure Plus type PT-R**

- par pièce

N° de com.	Finition	Plaque de montage	Profondeur	Emballage
059981	fer vieilli	dia. 50 mm	40 mm	1

**Crochet mural Pure Plus type PTT**

- par pièce

N° de com.	Finition	Plaque de montage	Profondeur	Emballage
060611	fer vieilli	50 x 50 mm	40 mm	1



Porte-papier Pure Plus

- par pièce



N° de com.	Finition	Longueur	Emballage
058795	fer vieilli	350 mm	1



Porte-papier toilet Pure Plus

- par pièce

N° de com.	Finition	Longueur	Emballage
058797	fer vieilli	150 mm	1

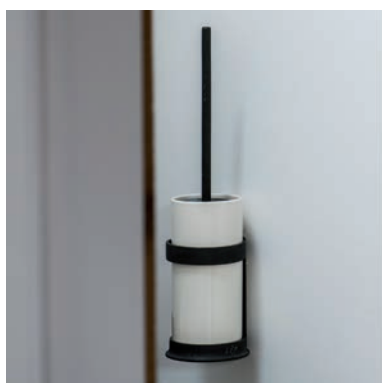

Brosse de toilette Pure Plus

- le kit contient:

- porte-brosse
- pot
- brosse

- par kit

N° de com.	Finition	-	Emballage
059940	fer vieilli/pot noir	-	1 kit
059944	fer vieilli/pot blanc	-	1 kit

ACCESSOIRES PURE PLUS Q

**Mains courantes avec supports Pure Q**

- crochets à commander séparément

- par pièce



N° de com.	Finition	Longueur	Diamètre	Hauteur	Emballage
060450	fer vieilli	1000 mm	14 mm	70 mm	1

**Support Pure Plus Q type PRst**

- pour mains courantes type Pure Plus Q

- par pièce

N° de com.	Finition	Hauteur	Emballage
060649	fer vieilli	70 mm	1

**Crochet Pure Plus Q type PRh**

- pour mains courantes Pure Plus Q

- par pièce

N° de com.	Finition	Hauteur	Emballage
060426	fer vieilli	50 mm	1

**Porte-papier Pure Plus Q**

- par pièce



N° de com.	Finition	Longueur	Emballage
060650	fer vieilli	370 mm	1



Porte-papier toilet Pure Plus Q

- par pièce

N° de com.	Finition	Longueur	Emballage
060651	fer vieilli	170 mm	1

POIGNÉES ET BOUTONS EN FER FORGÉ CDF



Bouton en fer forgé CDF type BT294

- fixation: 1 x M4

- par pièce

N° de com.	Finition	Ø	L	H	h	L	Emballage
058493	1 - polie verni	13 mm	37 mm	26 mm	15 mm	13 mm	1
058492	2 - rouillée	13 mm	37 mm	26 mm	15 mm	13 mm	1
059213	3 - noir	13 mm	37 mm	26 mm	15 mm	13 mm	1



Bouton en fer forgé CDF type BT254/BT284

- fixation: 1 x M4

- par pièce

N° de com.	Finition	Ø	L	H	h	L	Emballage
058621	1 - polie verni	16 mm	45 mm	37 mm	22 mm	14 mm	1
058505	1 - polie verni	18 mm	65 mm	55 mm	35 mm	25 mm	1
058622	2 - rouillée	16 mm	45 mm	37 mm	22 mm	14 mm	1
058504	2 - rouillée	18 mm	65 mm	55 mm	35 mm	25 mm	1
059214	3 - noir	16 mm	45 mm	37 mm	22 mm	14 mm	1
059215	3 - noir	18 mm	65 mm	55 mm	35 mm	25 mm	1



Bouton en fer forgé CDF type BT267

- fixation: 1 x M4

- par pièce

N° de com.	Finition	Ø	Ø	H	h	L	Emballage
058494	1 - polie verni	12 mm	31 mm	26 mm	19 mm	-	1
058495	2 - rouillée	12 mm	31 mm	26 mm	19 mm	-	1
059217	3 - noir	12 mm	31 mm	26 mm	19 mm	-	1



Bouton en fer forgé CDF type BT304-bis

- fixation: 1 x M4

- par pièce

N° de com.	Finition						
058500	1 - polie verni	16 mm	28 mm	32 mm	20 mm	-	1
058501	2 - rouillée	16 mm	28 mm	32 mm	20 mm	-	1
059219	3 - noir	16 mm	28 mm	32 mm	20 mm	-	1



Bouton en fer forgé CDF type BT270

- fixation: 1 x M4

- par pièce

N° de com.	Finition						
058499	1 - polie verni	11 mm	23 mm	21 mm	12 mm	-	1
058498	2 - rouillée	11 mm	23 mm	21 mm	12 mm	-	1
059218	3 - noir	11 mm	23 mm	21 mm	12 mm	-	1



Bouton en fer forgé CDF type Chemin de Fer

- fixation: 1 x M4

- par pièce





N° de com.	Finition						
059222	1 - polie verni	-	45 mm	40 mm	-	-	1
059223	2 - rouillée	-	45 mm	40 mm	-	-	1
059220	3 - noir	-	45 mm	40 mm	-	-	1



Poignée en fer forgé CDF type Chemin de Fer

- fixation: 2 x M4

- par pièce





N° de com.	Finition	 E	 L	 H	 h	
060642	1 - fer poli	96 mm	135 mm	36 mm	-	1
060644	1 - fer poli	128 mm	168 mm	36 mm	-	1
060647	1 - fer poli	160 mm	200 mm	36 mm	-	1
060643	2 - rouillé	96 mm	135 mm	36 mm	-	1
060645	2 - rouillé	128 mm	168 mm	36 mm	-	1
061003	3 - noir	160 mm	200 mm	36 mm	-	1
060641	3 - noir	96 mm	135 mm	36 mm	-	1
061003	3 - noir	128 mm	168 mm	36 mm	-	1
060646	3 - noir	160 mm	200 mm	36 mm	-	1



Poignée en fer forgé CDF type P13

- fixation: 2 x M4





- par pièce

N° de com.	Finition	 E	 L	 H	 h	
059479	1 - fer poli	135 mm	155 mm	35 mm	-	1
059362	2 - rouillé	135 mm	155 mm	35 mm	-	1
059404	3 - noir	135 mm	155 mm	35 mm	-	1



Poignée CDF Type Retro

- par pièce

N° de com.	Finition	 E	 L	 H	 h	
059878	noir	79 mm	91 mm	41 mm	-	1



Cuvette CDF type P46

- par pièce

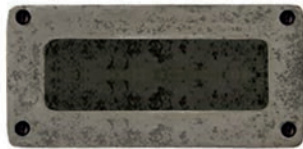

N° de com.	Finition	E	L	H	h	L	
059875	fer forgé	-	85 mm	-	-	40 mm	1

BOUTONS EN FER FORGÉ BOUVET



Bouton en fer forgé Bouvet type 167

- fixation: 1 x M4

- par pièce

N° de com.	Finition	Ø	L	H	h	L	
052224	1 - étain	13 mm	65 mm	36 mm	13 mm	22 mm	10
052228	2 - rouillée	13 mm	65 mm	36 mm	13 mm	22 mm	10



Bouton en fer forgé Bouvet type 143M

- fixation: 1 x M4

- par pièce

N° de com.	Finition	Ø	L	H	h	L	
052231	1 - étain	18 mm	90 mm	55 mm	23 mm	30 mm	10
052232	2 - rouillée	18 mm	90 mm	55 mm	23 mm	30 mm	10

BOUTONS ET POIGNÉES EN BRITANNIUM

BOUTONS ET POIGNÉES EN BRITANNIUM GIARA



**Bouton en Britannium Giara
type 304-bis**

- Britannium est un alliage d'argent et d'étain
- fixation: 1 x M4

- par pièce



N° de com.	Finition						
058534	britannium	12 mm	20 mm	27 mm	18 mm	+/- 20-21 mm	1
058510	britannium	16 mm	30 mm	32 mm	20 mm	+/- 29-30 mm	1
060653	britannium	-	40 mm	40 mm	25 mm	-	1



**Bouton en Britannium Giara
type Country Line C62**

- Britannium est un alliage d'argent et d'étain
- fixation: 1 x M4

- par pièce



N° de com.	Finition						
058508	britannium	16 mm	-	33 mm	20 mm	+/- 33 mm	1



**Poignée en Britannium Giara
type Country Line**

- Britannium est un alliage d'argent et d'étain
- fixation: 2 x M4

- par pièce



N° de com.	Finition	E	L	H	h	L	
058506	britannium	96 mm	125 mm	33 mm	25 mm	10 mm	1
058542	britannium	128 mm	156 mm	35 mm	25 mm	12 mm	1
058507	britannium	160 mm	180 mm	35 mm	25 mm	12 mm	1



**Bouton Giara
type Chemin de Fer**

- Britannium est un alliage d'argent et d'étain
- fixation: 1 x M4

- par pièce

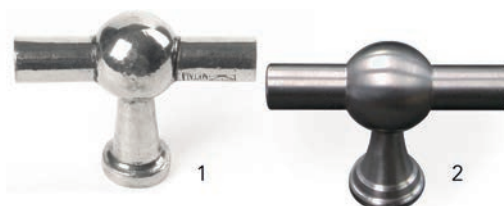







N° de com.	Finition	Ø	L	H	h	L	
058509	1 - britannium	14 mm	46 mm	36 mm	20 mm	17 mm	1
058603	2 - nickelée mat	16 mm	48 mm	38 mm	24 mm	18 mm	1



**Poignée en Britannium Giara
type Chemin de Fer Ma8**

- Britannium est un alliage d'argent et d'étain
- fixation: 2 x M4

- par pièce

N° de com.	Finition						
058535	britannium	64 mm	98 mm	36 mm	23 mm	8 mm	1
058536	britannium	96 mm	128 mm	36 mm	23 mm	8 mm	1
058537	britannium	128 mm	168 mm	36 mm	23 mm	8 mm	1
058538	britannium	224 mm	258 mm	36 mm	23 mm	10 mm	1
058539	britannium	384 mm	428 mm	43 mm	27 mm	11 mm	1
058540	britannium	512 mm	556 mm	43 mm	27 mm	11 mm	1









**Bouton en Britannium Giara
type PO.IN**

- Britannium est un alliage d'argent et d'étain
- fixation: 1 x M4

- par pièce



N° de com.	Finition						
058544	britannium	13 mm	35 mm	26 mm	16 mm	11 mm	1
058545	britannium	16 mm	46 mm	36 mm	22 mm	14 mm	1
058546	britannium	22 mm	59 mm	58 mm	38 mm	24 mm	1









**Bouton en Britannium Giara
type Stone POS**

- Britannium est un alliage d'argent et d'étain
- fixation: 1 x M4

- par pièce



N° de com.	Finition						
058547	britannium	13 mm	-	27 mm	12 mm	18 mm	1
058548	britannium	14 mm	-	38 mm	17 mm	23 mm	1









**Bouton en Britannium Giara
type C64-48**

- Britannium est un alliage d'argent et d'étain
- fixation: 1 x M4

- par pièce



N° de com.	Finition						
058550	britannium	16 mm	-	33 mm	15 mm	21 mm	1









**Poignée en Britannium Giara
type C65**

- Britannium est un alliage d'argent et d'étain
- fixation: 2 x M4

- par pièce









N° de com.	Finition						
058549	britannium	86 mm	104 mm	22 mm	18 mm	-	1



**Poignée en Britannium Giara
type MAR-25**

- Britannium est un alliage d'argent et d'étain

- par pièce

N° de com.	Finition						
058543	britannium	25 mm	34 mm	34 mm	43 mm	8 mm	1

POIGNÉES ET BOUTONS EN CUIR

POIGNÉES ET BOUTONS EN CUIR COVRE

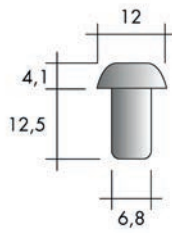

Boucle en cuir type 107

- fixation: 2 x M4

- par pièce

N° de com.	Finition	E	L	H	h	L	
056788	cuir naturel/nickelé	32 mm	96 mm	-	13 mm	5 mm	1
057387	cuir naturel/nickelé	64 mm	125 mm	-	13 mm	5 mm	1
057388	cuir naturel/nickelé	128 mm	195 mm	-	13 mm	5 mm	1



Boucle en cuir type 110

- fixation: 1 x M4

- par pièce

N° de com.	Finition	Ø	Ø	H	h	L	
056795	cuir naturel/nickelé	14 mm	18 mm	40 mm	12 mm	5 mm	1



Boucle en cuir type 113

- fixation: 1 x M4

- par pièce

N° de com.	Finition	Ø	Ø	H	h	L	
057391	cuir naturel/nickelé	6 mm	15 mm	39 mm	8 mm	5 mm	1

POIGNÉES LONGUES

POIGNÉES LONGUES

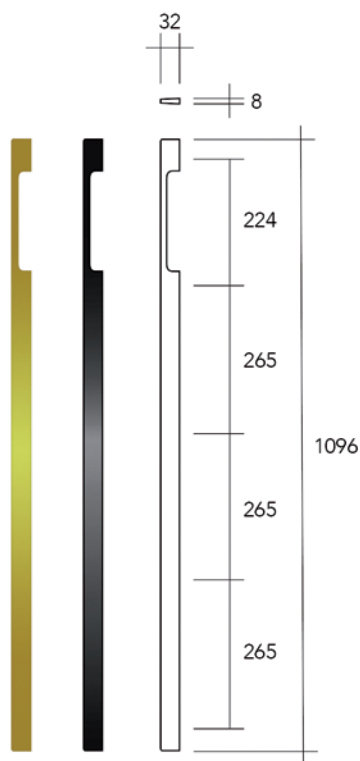

Poignée longue type 392

- fixation: 5 x M4
- noir mat: aluminium anodisé
- or mat: aluminium laqué
- par pièce

N° de com.	Finition	Longueur	Emballage
039204	or mat	1096 mm	1
039200	noir mat	1096 mm	1

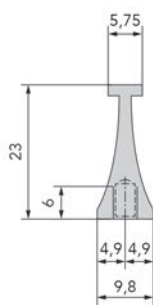

Poignée longue type 3659

- fixation: 2, 3 ou 4 x M4
- voir fiche technique
- par pièce

N° de com.	Finition	Longueur	Emballage
059622	noir anodisé	180 mm	1
059623	noir anodisé	410 mm	1
059624	noir anodisé	560 mm	1
059625	noir anodisé	760 mm	1
059626	noir anodisé	1160 mm	1
059318	noir anodisé	1400 mm	1

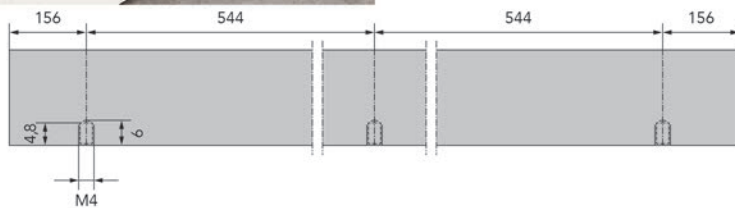
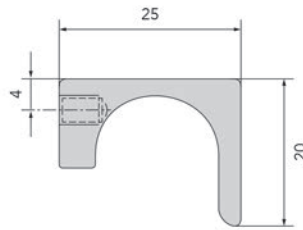

Poignée longue type 3610

- fixation: 3 x M4

- par pièce

N° de com.	Finition	Longueur	Emballage
059319	inox look	1400 mm	1



Poignée longue type US10

- matière première: acier

- fixation: 2 ou 3 x M4

- longueur 832 mm: 2 pieds

- longueur 1792 mm: 3 pieds

- par pièce

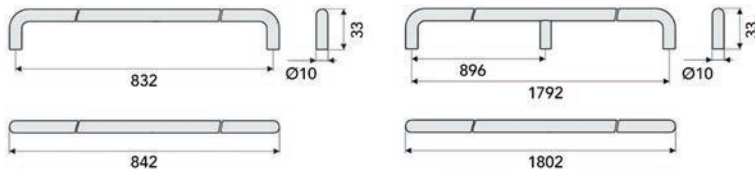

N° de com.	Finition	E	L	H	h	L	
059702	or mat	832 mm	842 mm	33 mm	23 mm	10 mm	1
059703	noir mat	832 mm	842 mm	33 mm	23 mm	10 mm	1
059704	or mat	1792 mm	1802 mm	33 mm	23 mm	10 mm	1
059705	noir mat	1792 mm	1802 mm	33 mm	23 mm	10 mm	1

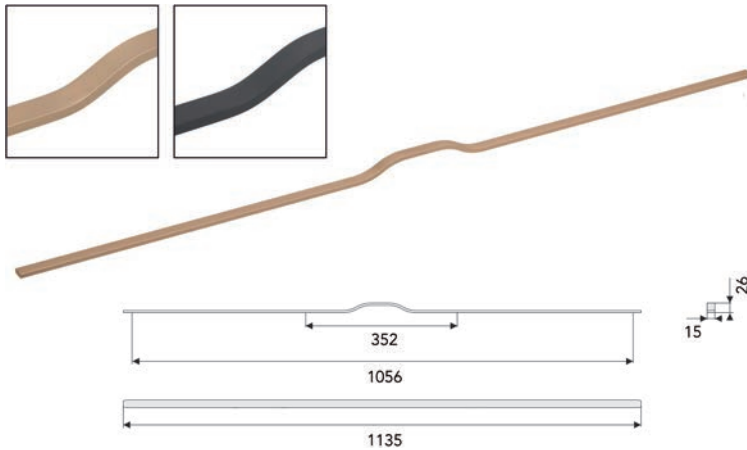

Poignée longue type UA130

- matière première: aluminium
- fixation: 4 x M4
- par pièce

N° de com.	Finition	E	L	H	h	L	
059707	or mat	352/1056 mm	1135 mm	26 mm	-	15 mm	1
059706	noir mat	352/1056 mm	1135 mm	26 mm	-	15 mm	1

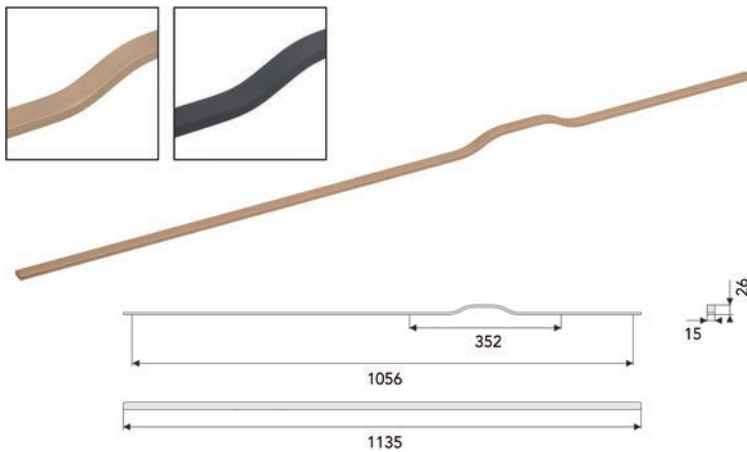

Poignée longue type UA131

- matière première: aluminium
- fixation: 4 x M4
- par pièce

N° de com.	Finition	E	L	H	h	L	
059709	or mat	352/1056 mm	1135 mm	26 mm	-	15 mm	1
059708	noir mat	352/1056 mm	1135 mm	26 mm	-	15 mm	1

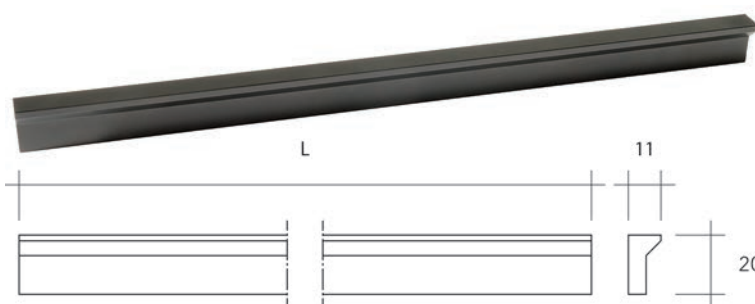

Poignée longue type AL2326

- matière première: aluminium
- fixation:
 - longueur 447 mm: 2 x M4
 - longueur 897 mm: 3 x M4
- par pièce

N° de com.	Finition	Longueur (L)	Emballage
060918	noir mat	447 mm	1
060917	noir mat	897 mm	1

POIGNÉES POUR PORTES COULISSANTES

POIGNÉES POUR PORTES COULISSANTES

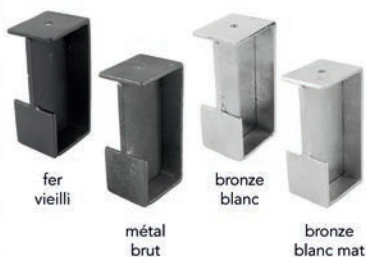
**Poignée pour portes coulissantes type PRSD**

- seulement pour portes coulissantes
avec une épaisseur de 40 mm

- par pièce

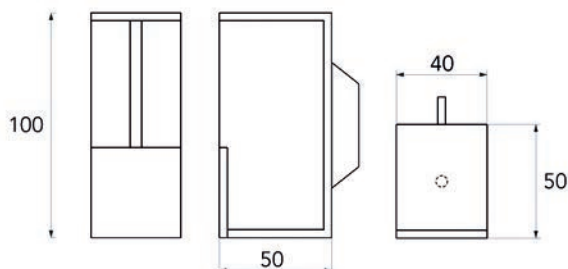

N° de com.	Finition	Largeur	Profondeur	Hauteur	Emballage
059942	métal brut	40 mm	50 mm	100 mm	4
059406	fer vieilli	40 mm	50 mm	100 mm	4
059403	bronze blanc	40 mm	50 mm	100 mm	4
059943	bronze blanc mat	40 mm	50 mm	100 mm	4

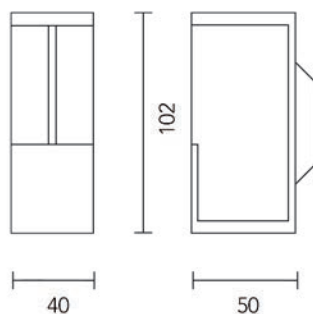
**Poignée pour porte coulissante Carré massif**

- matière première: inox AISI 304

- par pièce

N° de com.	Finition	Largeur	Profondeur	Hauteur	Emballage
016080	inox	40 mm	50 mm	102 mm	1
016081	noir mat	40 mm	50 mm	102 mm	1

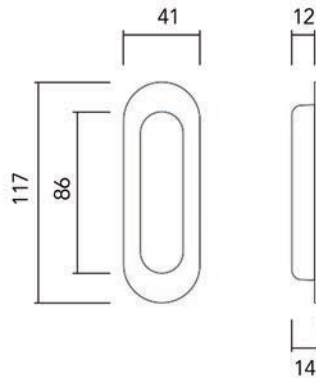

Poignée pour porte coulissante Oval aveugle

- matière première: inox AISI 304

- par pièce

N° de com.	Finition	-	Emballage
016082	inox	-	1
016083	noir mat	-	1

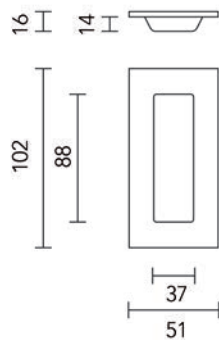

Poignée pour porte coulissante Oval carré

- matière première: inox AISI 304

- par pièce

N° de com.	Finition	-	Emballage
016084	inox	-	1
016085	noir mat	-	1

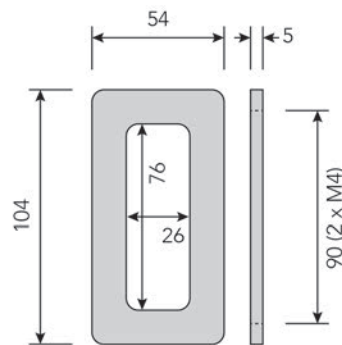

Poignée pour portes coulissantes type 8899

- avec une épaisseur réduite de seulement 5 mm

- à visser (2 x M4) ou à coller

(livré avec 2 bandes adhésives)

- entraxe: 90 mm

- par pièce

N° de com.	Finition	-	Emballage
014017	aluminium	-	1
014018	blanc	-	1
014019	noir mat	-	1

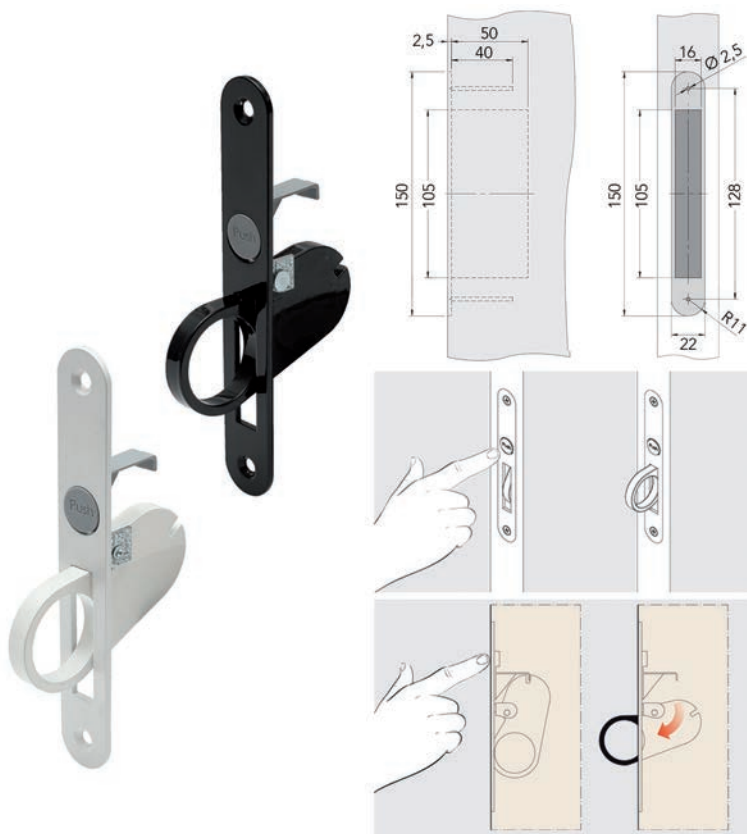

Poignée push pour porte coulissante

- poignée à encastrer: en appuyant sur le bouton, la poignée est éjectée

- par pièce

N° de com.	Finition	-	Emballage
014021	blanc (métal)	-	1
014022	noir (métal)	-	1

ACCESSOIRES

EMBASE FRONTAL



Embase frontal

- L'embase permet un montage frontal d'une poignée.
Une poignée (longue) pourrait ainsi faire office de porte-essuie.

- par pièce

N° de com.	Finition	Largeur	Hauteur	Epaisseur	Entraxe	Emballage
059532	nickelée	15 mm	40 mm	3 mm	30 mm	25



Vis pour Embase frontal

- par pièce

N° de com.	Description	Diamètre	Longueur	Emballage
003531	PZ2	M4	12 mm	1

INSERT

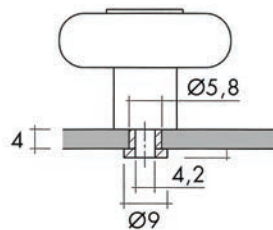
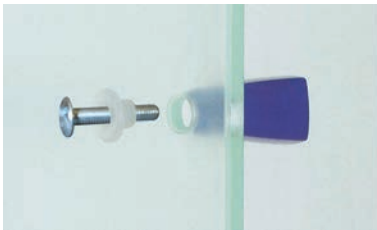

Insert type D6

Protège une porte glace au montage d'un bouton ou d'une poignée.

- par pièce

N° de com.	Finition	pour verre de		Emballage
013156	transparent	4 mm		1

VIS

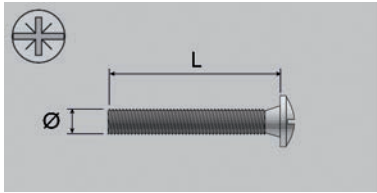
**Vis type M4**

- vis pour boutons et poignées

- par pièce

N° de com.	Finition	Diamètre	Longueur	Emballage
052269	zingué	4 mm	10 mm	100
052271	zingué	4 mm	15 mm	100
052273	zingué	4 mm	20 mm	100
052274	zingué	4 mm	21 mm	100
052275	zingué	4 mm	22 mm	100
052276	zingué	4 mm	23 mm	100
052277	zingué	4 mm	25 mm	100
052278	zingué	4 mm	28 mm	100
052279	zingué	4 mm	30 mm	100
052280	zingué	4 mm	35 mm	100
054506	zingué	4 mm	38 mm	100
052282	zingué	4 mm	40 mm	100
052283	zingué	4 mm	43 mm	100
052284	zingué	45 mm	45 mm	100
003487	zingué	4 mm	50 mm	100
003499	zingué	4 mm	60 mm	100

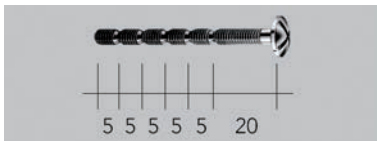
**Vis type M4 autocassante**

- autocassante par 5 mm

- par pièce

N° de com.	Finition	Longueur	Longueur minimum	Détachable	Emballage
059171	zingué	45 mm	20 mm	5 mm	5000

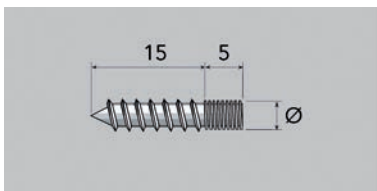
**Broche type M4**

- broche pour boutons et poignées

- par pièce

N° de com.	Finition	-	Emballage
003490	nickelé	4 mm	1

ARRÊTS DE PORTE

ARRÊTS DE PORTE

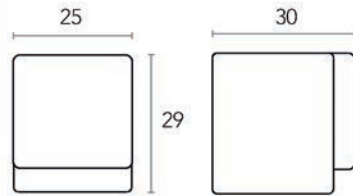

Arrêt de porte type FP05

- vis, cheville et autocollant 3M pour fixation inclus

- par pièce

N° de com.	Finition	Largeur	Profondeur	Hauteur	Emballage
060464	chromé mat	25 mm	30 mm	29 mm	24

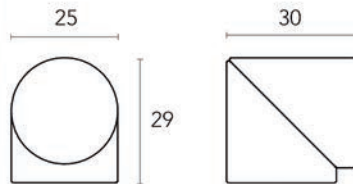

Arrêt de porte type FP10

- vis, cheville et autocollant 3M pour fixation inclus

- par pièce

N° de com.	Finition	Largeur	Profondeur	Hauteur	Emballage
060465	chromé mat	25 mm	30 mm	29 mm	24

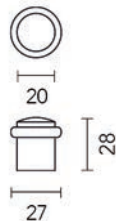

Arrêt de porte type Bora

- matière première: inox AISI 304

- par pièce

N° de com.	Finition			Emballage
016114	noir mat	-	-	1

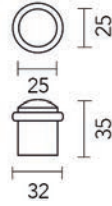
**Arrêt de porte type Massif**

- matière première: inox AISI 304

- par pièce

N° de com.	Finition	-	Emballage
016118	noir mat	-	1

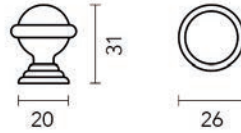
**Arrêt de porte type Retro**

- matière première: laiton

- par pièce

N° de com.	Finition	-	Emballage
016119	noir mat	-	1

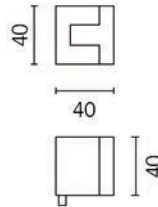
**Arrêt de porte type Carré**

- matière première: inox AISI 304

- par pièce

N° de com.	Finition	-	Emballage
016115	noir mat	-	1

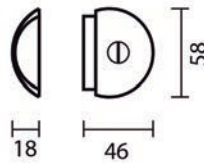
**Arrêt de porte type Demie lune**

- matière première: inox AISI 304

- hauteur: 18 mm

- par pièce

N° de com.	Finition	-	Emballage
016116	noir mat	-	1

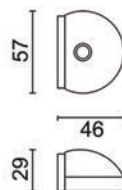
**Arrêt de porte type Demie lune**

- matière première: inox AISI 304

- hauteur: 29 mm

- par pièce

N° de com.	Finition	-	Emballage
016117	noir mat	-	1

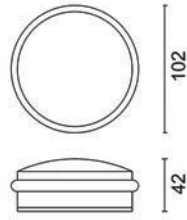

Arrêt de porte

- matière première: inox AISI 304

- par pièce

N° de com.	Finition	Poids	Emballage
016113	noir mat	1,25 kg	1

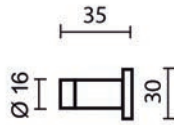

Arrêt de porte mural

- matière première: inox AISI 304

- par pièce

N° de com.	Finition	-	Emballage
016111	noir mat	-	1

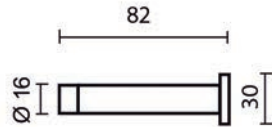

Arrêt de porte mural

- matière première: inox AISI 304

- par pièce

N° de com.	Finition	-	Emballage
016112	noir mat	-	1

POIGNÉES DE PORTE ET ACCESSOIRES

POIGNÉES DE PORTE

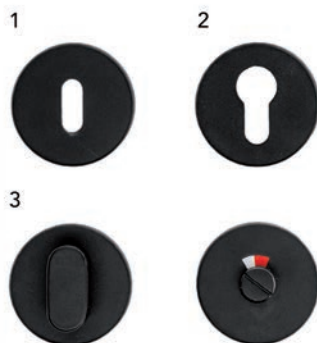
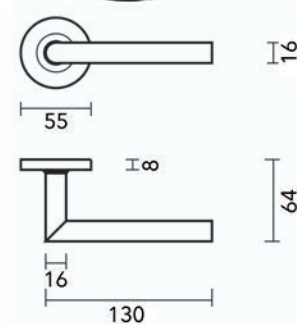
**Poignée de porte Pro I-shape Ø 16 mm**

- matière première: inox AISI 304
- double ressort
- fixation vis à travers (vis à travers inclus)
- finition: peinture en poudre noir mat
- épaisseur tube: 1 mm
- par paire

N° de com.	Finition	Description	Emballage
016020	noir mat	2 poignées porte avec 2 rosaces pour porte intérieure (1)	1 pr
016021	noir mat	2 poignées porte avec 2 rosaces pour serrure à cylindre (2)	1 pr
016023	noir mat	2 poignées porte avec kit wc (3)	1 pr
016022	noir mat	2 poignées porte sans rosaces	1 pr

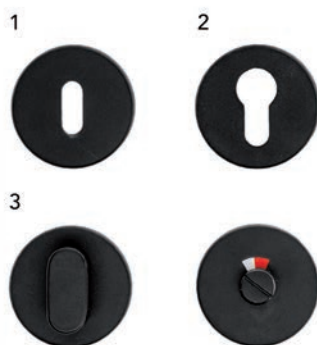
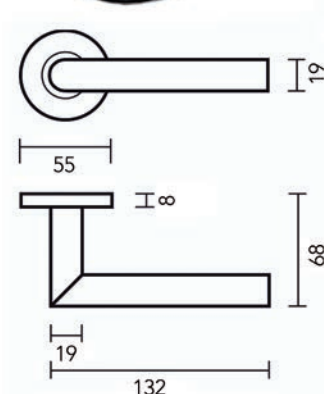
**Poignée de porte Pro I-shape Ø 19 mm**

- matière première: inox AISI 304
- double ressort
- fixation vis à travers (vis à travers inclus)
- finition: peinture en poudre noir mat
- épaisseur tube: 1 mm
- par paire

N° de com.	Finition	Description	Emballage
016024	noir mat	2 poignées porte avec 2 rosaces pour porte intérieure (1)	1 pr
016025	noir mat	2 poignées porte avec 2 rosaces pour serrure à cylindre (2)	1 pr
016027	noir mat	2 poignées porte avec kit wc (3)	1 pr
016026	noir mat	2 poignées porte sans rosaces	1 pr

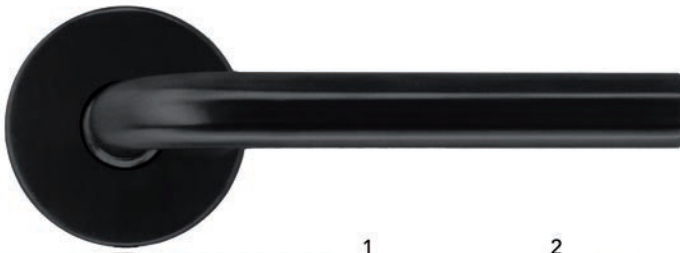

Poignée de porte Pro L-shape Ø 16 mm

- matière première: inox AISI 304
- double ressort
- fixation vis à travers (vis à travers inclus)
- finition: peinture en poudre noir mat
- épaisseur tube: 1 mm
- par paire

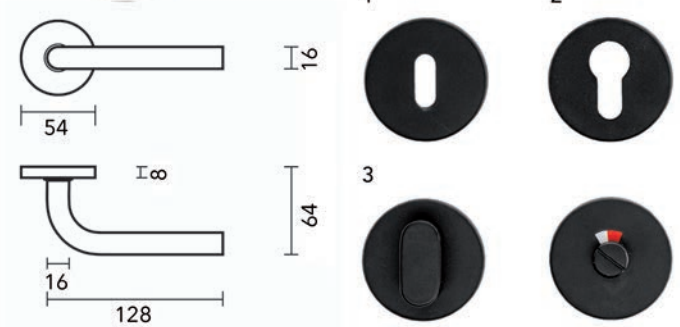

N° de com.	Finition	Description	Emballage
016032	noir mat	2 poignées porte avec 2 rosaces pour porte intérieure (1)	1 pr
016033	noir mat	2 poignées porte avec 2 rosaces pour serrure à cylindre (2)	1 pr
016035	noir mat	2 poignées porte avec kit wc (3)	1 pr
016034	noir mat	2 poignées porte sans rosaces	1 pr



Poignée de porte L-shape Ø 19 mm

- matière première: inox AISI 304
- double ressort
- fixation vis à travers (vis à travers inclus)
- finition: peinture en poudre noir mat
- épaisseur tube: 1 mm
- par paire

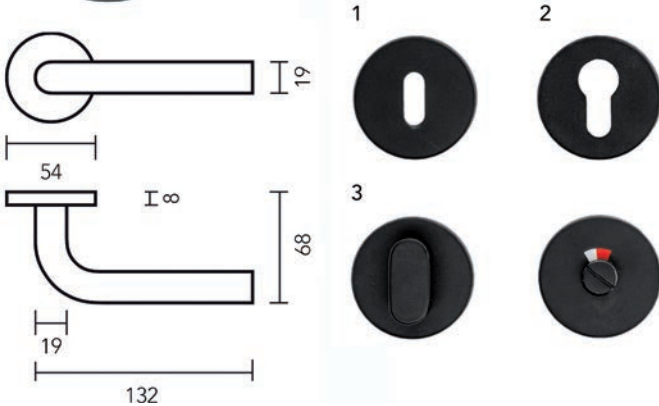

N° de com.	Finition	Description	Emballage
016036	noir mat	2 poignées porte avec 2 rosaces pour porte intérieure (1)	1 pr
016037	noir mat	2 poignées porte avec 2 rosaces pour serrure à cylindre (2)	1 pr
016039	noir mat	2 poignées porte avec kit wc (3)	1 pr
016038	noir mat	2 poignées porte sans rosaces	1 pr



Poignée de porte Pro Oval C-shape

- matière première: inox AISI 304
- fixation vis à travers (vis à travers inclus)
- finition: peinture en poudre noir mat

- par paire

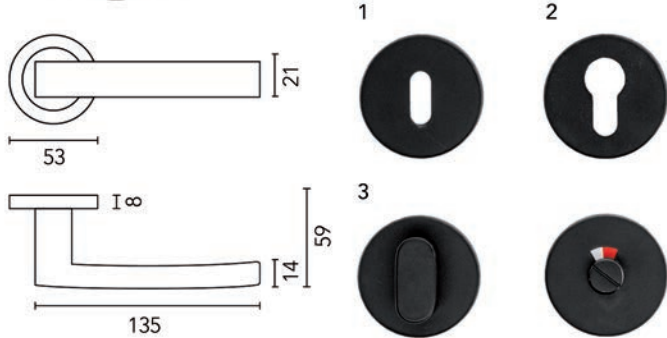

N° de com.	Finition	Description	Emballage
016044	noir mat	2 poignées porte avec 2 rosaces pour porte intérieure (1)	1 pr
016045	noir mat	2 poignées porte avec 2 rosaces pour serrure à cylindre (2)	1 pr
016047	noir mat	2 poignées porte avec kit wc (3)	1 pr
016046	noir mat	2 poignées porte sans rosaces	1 pr



Poignée de porte Pro Ellips

- matière première: inox AISI 304
- double ressort
- fixation vis à travers (vis à travers inclus)
- finition: peinture en poudre noir mat
- épaisseur tube: 1 mm

- par paire

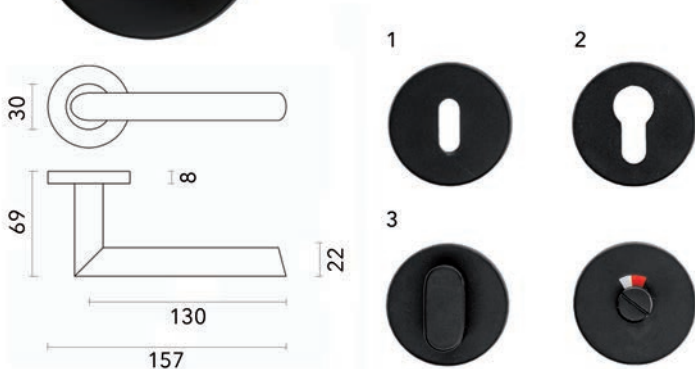

N° de com.	Finition	Description	Emballage
016008	noir mat	2 poignées porte avec 2 rosaces pour porte intérieure (1)	1 pr
016009	noir mat	2 poignées porte avec 2 rosaces pour serrure à cylindre (2)	1 pr
016011	noir mat	2 poignées porte avec kit wc (3)	1 pr
016010	noir mat	2 poignées porte sans rosaces	1 pr

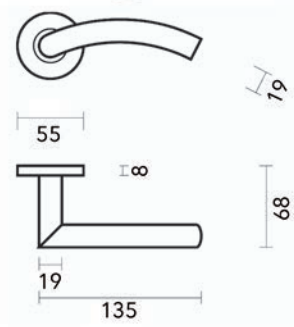

Poignée de porte Pro GI-shape

- matière première: inox AISI 304
- double ressort
- fixation vis à travers (vis à travers inclus)
- finition: peinture en poudre noir mat
- épaisseur tube: 1 mm
- par paire

N° de com.	Finition	Description	Emballage
016012	noir mat	2 poignées porte avec 2 rosaces pour porte intérieure (1)	1 pr
016013	noir mat	2 poignées porte avec 2 rosaces pour serrure à cylindre (2)	1 pr
016015	noir mat	2 poignées porte avec kit wc (3)	1 pr
016014	noir mat	2 poignées porte sans rosaces	1 pr

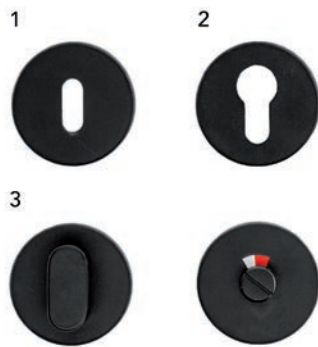
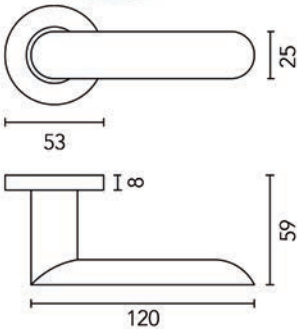
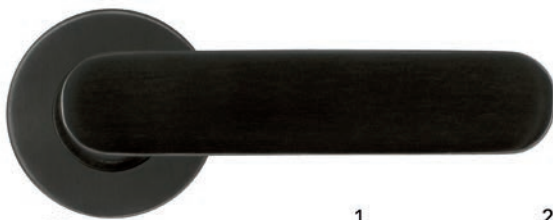

Poignée de porte Pro Space

- matière première: inox AISI 304
- double ressort
- fixation vis à travers (vis à travers inclus)
- finition: peinture en poudre noir mat
- épaisseur tube: 1 mm
- par paire

N° de com.	Finition	Description	Emballage
016064	noir mat	2 poignées porte avec 2 rosaces pour porte intérieure (1)	1 pr
016065	noir mat	2 poignées porte avec 2 rosaces pour serrure cylindre (2)	1 pr
016067	noir mat	2 poignées porte avec kit wc (3)	1 pr
016066	noir mat	2 poignées porte sans rosaces	1 pr



Poignée de porte Pro Sipora

- matière première: inox AISI 304
- double ressort
- finition: peinture en poudre noir mat
- par paire

N° de com.	Finition	Description	Emballage
016060	noir mat	2 poignées porte avec 2 rosaces pour porte intérieure (1)	1 pr
016061	noir mat	2 poignées porte avec 2 rosaces pour serrure à cylindre (2)	1 pr
016063	noir mat	2 poignées porte avec kit wc (3)	1 pr
016062	noir mat	2 poignées porte sans rosaces	1 pr

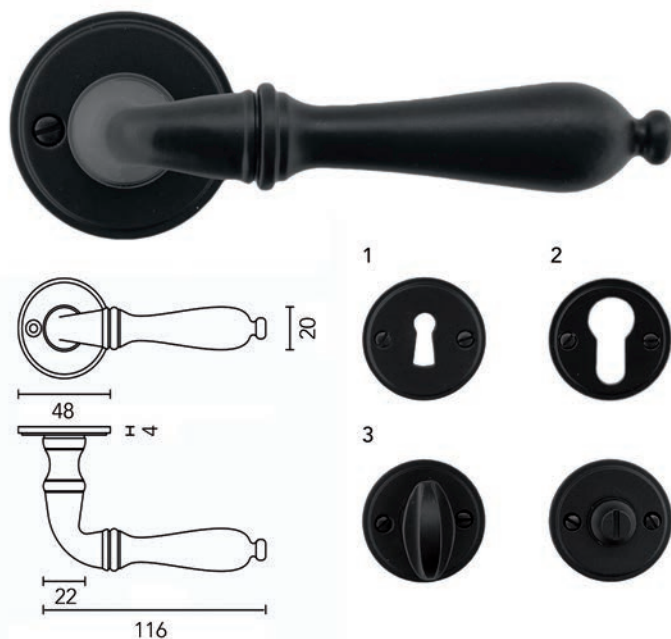

Poignée de porte Pro Da Vinci

- matière première: laiton
- pas de ressort
- pas de montage avec vis à travers possible
- finition: peinture en poudre noir mat
- par paire

N° de com.	Finition	Description	Emballage
016004	noir mat	2 poignées porte avec 2 rosaces pour porte intérieure (1)	1 pr
016005	noir mat	2 poignées porte avec 2 rosaces pour serrure à cylindre (2)	1 pr
016007	noir mat	2 poignées porte avec kit wc (3)	1 pr
016006	noir mat	2 poignées porte sans rosaces	1 pr



Poignée de porte Pro Gretana

- matière première: laiton
- pas de ressort
- pas de montage avec vis à travers possible
- finition: peinture en poudre noir mat

- par paire

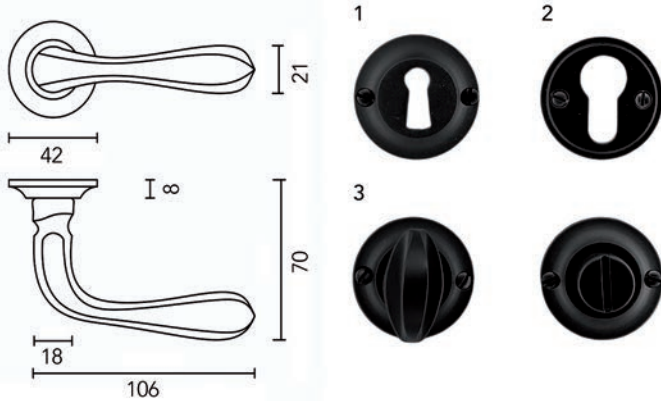

N° de com.	Finition	Description	Emballage
016016	noir mat	2 poignées porte avec 2 rosaces pour porte intérieure (1)	1 pr
016017	noir mat	2 poignées porte avec 2 rosaces pour serrure à cylindre (2)	1 pr
016019	noir mat	2 poignées porte avec kit wc (3)	1 pr
016018	noir mat	2 poignées porte sans rosaces	1 pr



Poignée de porte Pro Petana L + L

- matière première: laiton
- pas de ressort
- pas de montage avec vis à travers possible
- finition: peinture en poudre noir mat

- par paire

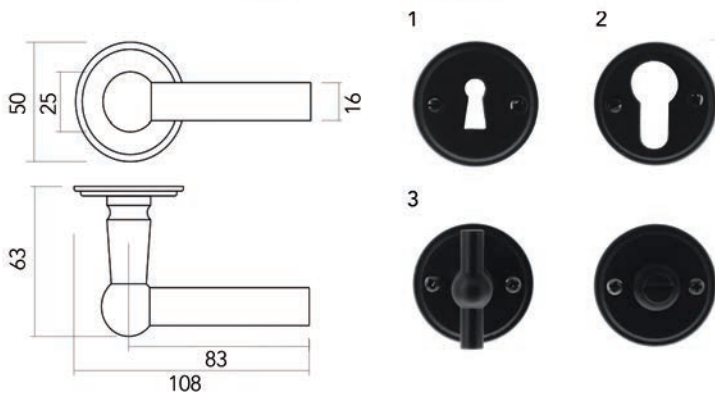

N° de com.	Finition	Description	Emballage
016048	noir mat	2 poignées porte avec 2 rosaces pour porte intérieure (1)	1 pr
016049	noir mat	2 poignées porte avec 2 rosaces pour serrure à cylindre (2)	1 pr
016051	noir mat	2 poignées porte avec kit wc (3)	1 pr
016050	noir mat	2 poignées porte sans rosaces	1 pr

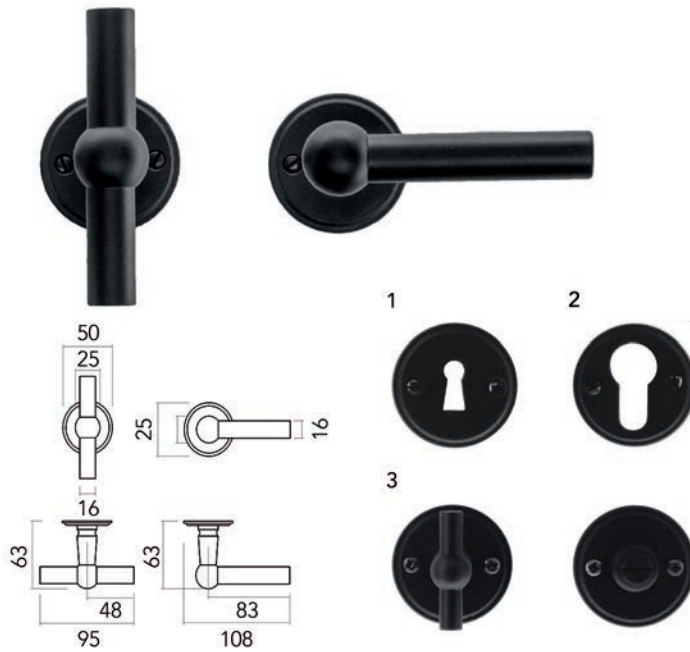

Poignée de porte Pro Petana T + L

- matière première: laiton
- pas de ressort
- pas de montage avec vis à travers possible
- finition: peinture en poudre noir mat

- par paire

N° de com.	Finition	Description	Emballage
016052	noir mat	2 poignées porte avec 2 rosaces pour porte intérieure (1)	1 pr
016053	noir mat	2 poignées porte avec 2 rosaces pour serrure à cylindre (2)	1 pr
016055	noir mat	2 poignées porte avec kit wc (3)	1 pr
016054	noir mat	2 poignées porte sans rosaces	1 pr

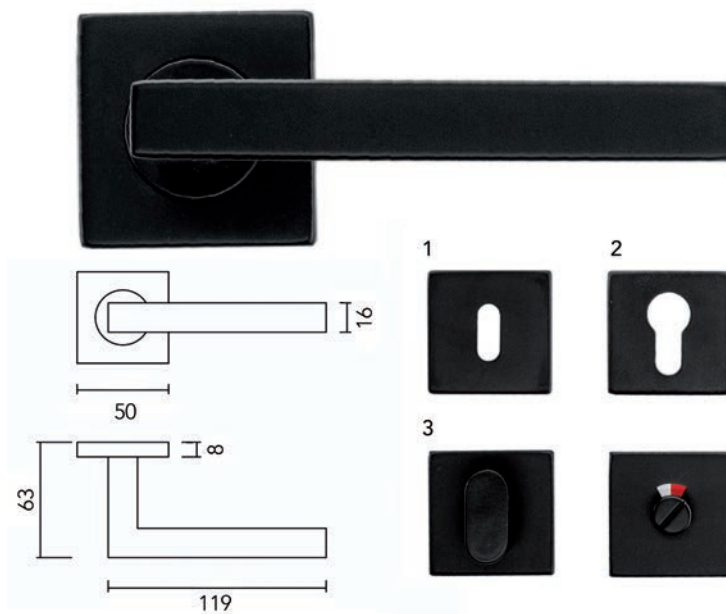

Poignée de porte Pro Kubic shape

- matière première: inox AISI 304
- double ressort
- fixation vis à travers (vis à travers inclus)
- finition: peinture en poudre noir mat
- épaisseur tube: 1 mm

- par paire

N° de com.	Finition	Description	Emballage
016028	noir mat	2 poignées porte avec 2 rosaces pour porte intérieure (1)	1 pr
016029	noir mat	2 poignées porte avec 2 rosaces pour serrure à cylindre (2)	1 pr
016031	noir mat	2 poignées porte avec kit wc (3)	1 pr
016030	noir mat	2 poignées porte sans rosaces	1 pr

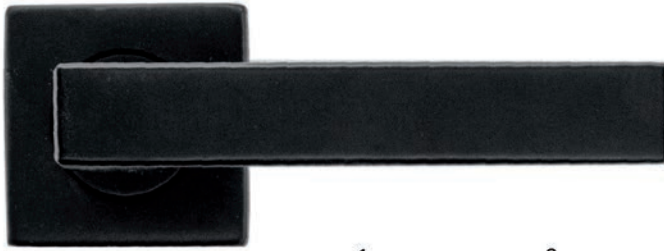

Poignée de porte Pro Cosmic

- matière première: inox AISI 304
- double ressort
- fixation vis à travers (vis à travers inclus)
- fixation rosace: 2 x 4 clips
- finition: peinture en poudre noir mat
- par paire

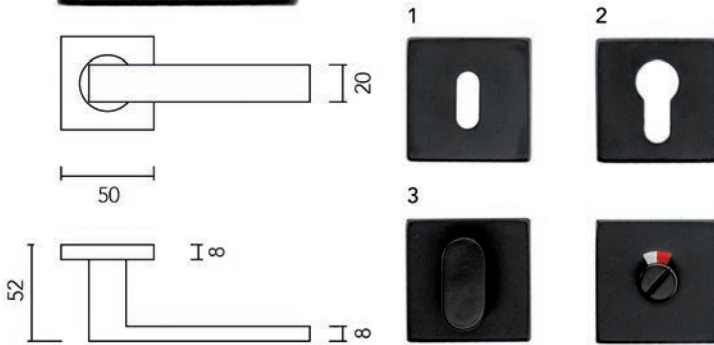

N° de com.	Finition	Description	Emballage
016000	noir mat	2 poignées porte avec 2 rosaces pour porte intérieure (1)	1 pr
016001	noir mat	2 poignées porte avec 2 rosaces pour serrure à cylindre (2)	1 pr
016003	noir mat	2 poignées porte avec kit wc (3)	1 pr
016002	noir mat	2 poignées porte sans rosaces	1 pr



Poignée de porte Pro Luis

- matière première: zamac
- double ressort
- pas de montage avec vis à travers possible
- finition: peinture en poudre noir mat
- par paire

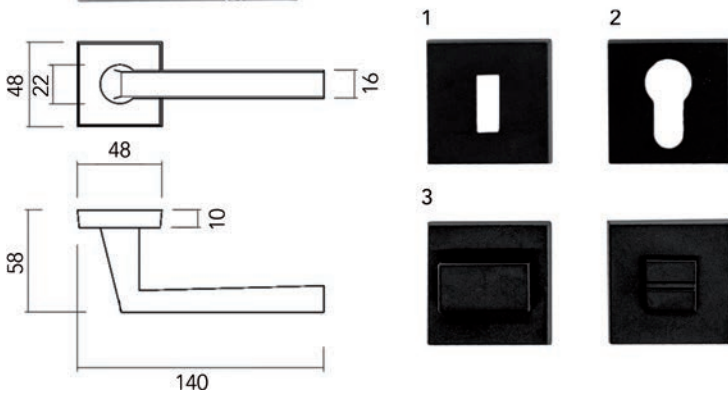

N° de com.	Finition	Description	Emballage
016040	noir mat	2 poignées porte avec 2 rosaces pour porte intérieure (1)	1 pr
016041	noir mat	2 poignées porte avec 2 rosaces pour serrure à cylindre (2)	1 pr
016043	noir mat	2 poignées porte avec kit wc (3)	1 pr
016042	noir mat	2 poignées porte sans rosaces	1 pr

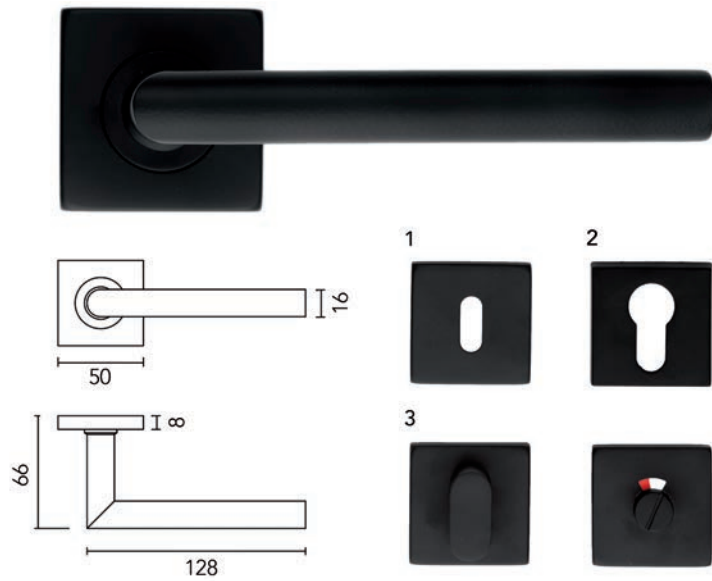

Poignée de porte Pro Square I-shape: Ø 16 mm

- matière première: inox AISI 304
- double ressort
- fixation vis à travers (vis à travers inclus)
- finition: peinture en poudre noir mat
- épaisseur tube: 1 mm

- par paire

N° de com.	Finition	Description	Emballage
016068	noir mat	2 poignées porte avec 2 rosaces pour porte intérieure (1)	1 pr
016069	noir mat	2 poignées porte avec 2 rosaces pour serrure à cylindre (2)	1 pr
016071	noir mat	2 poignées porte avec kit wc (3)	1 pr
016070	noir mat	2 poignées porte sans rosaces	1 pr

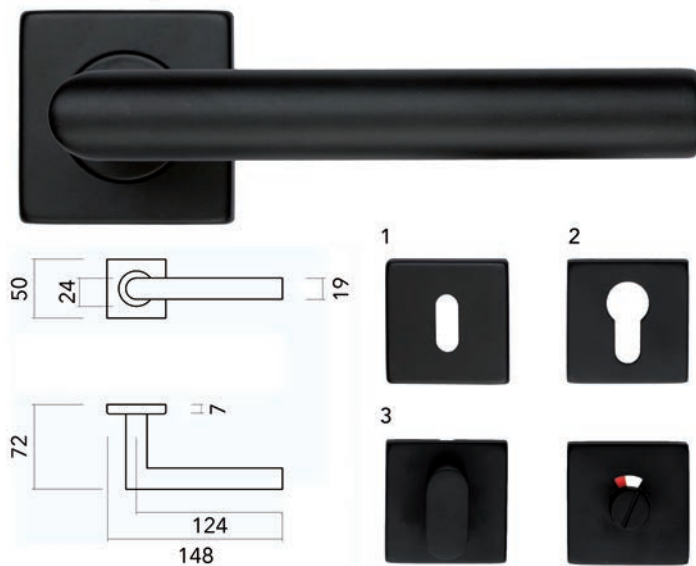

Poignée de porte Pro Square I-shape: Ø 19 mm

- matière première: inox AISI 304
- double ressort
- fixation vis à travers (vis à travers inclus)
- finition: peinture en poudre noir mat
- épaisseur tube: 1 mm

- par paire

N° de com.	Finition	Description	Emballage
016072	noir mat	2 poignées porte avec 2 rosaces pour porte intérieure (1)	1 pr
016073	noir mat	2 poignées porte avec 2 rosaces pour serrure à cylindre (2)	1 pr
016075	noir mat	2 poignées porte avec kit wc (3)	1 pr
016074	noir mat	2 poignées porte sans rosaces	1 pr



Poignée de porte Pro X-Treme

- matière première: zamac
- double ressort
- vis à travers inox (vis à travers inclus)
- finition: peinture en poudre noir mat

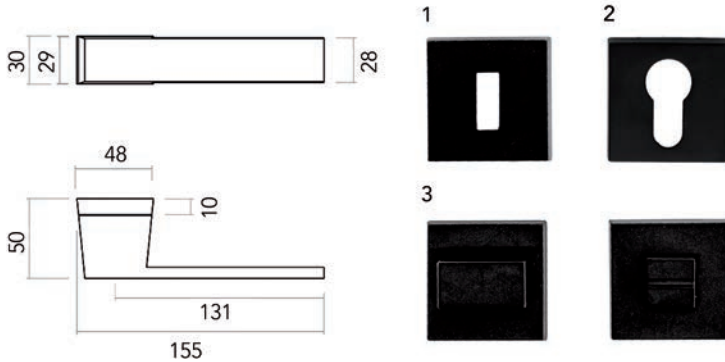

- par paire

N° de com.	Finition	Description	Emballage
016076	noir mat	2 poignées porte avec 2 rosaces pour porte intérieure (1)	1 pr
016077	noir mat	2 poignées porte avec 2 rosaces pour serrure à cylindre (2)	1 pr
016079	noir mat	2 poignées porte avec kit wc (3)	1 pr
016078	noir mat	2 poignées porte sans rosaces	1 pr



Poignée de porte Pro Seliz

- matière première: zamac
- double ressort
- vis à travers inox (vis à travers inclus)
- finition: peinture en poudre noir mat

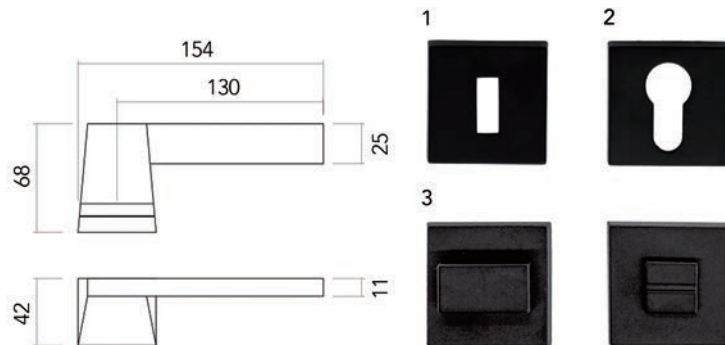

- par paire

N° de com.	Finition	Description	Emballage
016056	noir mat	2 poignées porte avec 2 rosaces pour porte intérieure (1)	1 pr
016057	noir mat	2 poignées porte avec 2 rosaces pour serrure à cylindre (2)	1 pr
016059	noir mat	2 poignées porte avec kit wc (3)	1 pr
016058	noir mat	2 poignées porte sans rosaces	1 pr

PAUMELLES

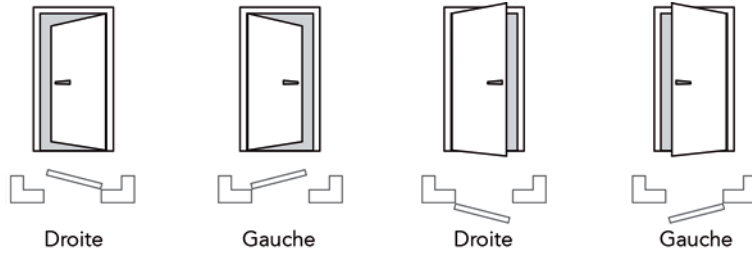

Nous mentionnons le sens de rotation Belge, qui est également utilisé en France. Aux Pays-Bas et en Allemagne, ils utilisent la norme DIN (l'inverse). Consultez le dessin du haut et vous recevrez ainsi les paumelles correctes.

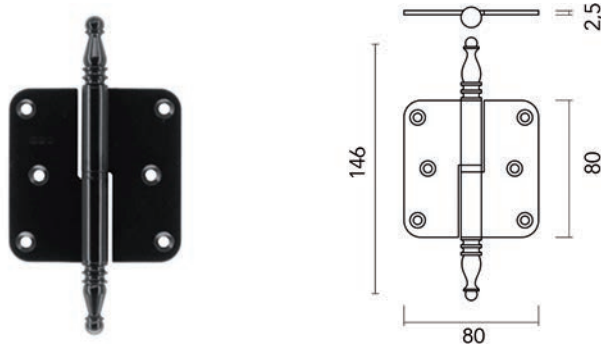

Paumelle Vase
- par pièce

N° de com.	Finition	Gauche/droite	Mesures	Emballage
016122	noir mat	gauche (Belge)	146/80 x 80 x 2,5 mm	1
016123	noir mat	droite (Belge)	146/80 x 80 x 2,5 mm	1



Paumelle 80 x 80
- par pièce

N° de com.	Finition	Gauche/droite	Mesures	Emballage
016124	noir mat	gauche (Belge)	80 x 80 x 2,5 mm	1
016125	noir mat	droite (Belge)	80 x 80 x 2,5 mm	1

PAUMELLES INVISIBLES



Paumelle AGB Eclipse 2

- réglage 3D
- pour cadre bloc
- par pièce

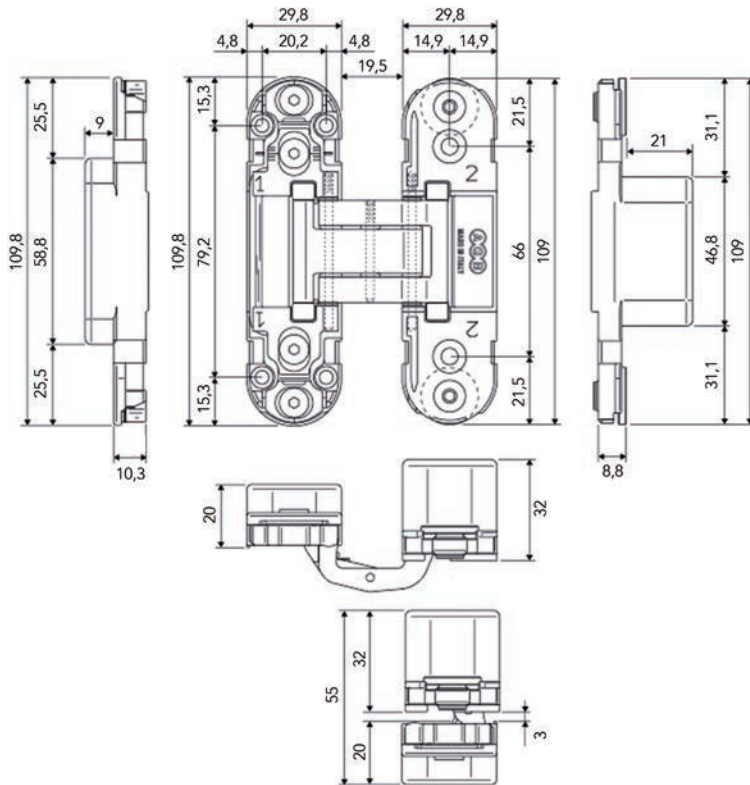

N° de com.	Finition	-	Emballage
016120	noir	-	1



Paumelle AGB Eclipse 3

- réglage 3D
- pour ouverture inverse et cadre bloc normal
- par pièce

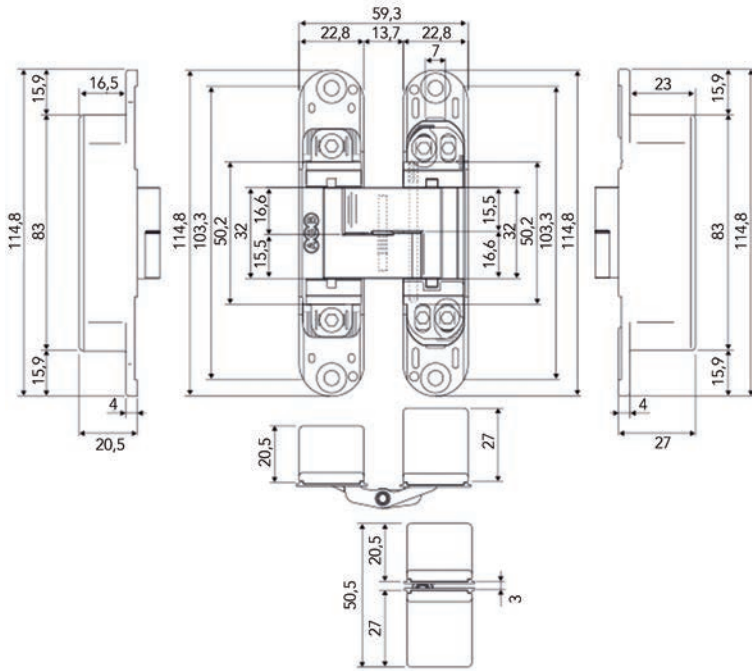

N° de com.	Finition		Emballage
016121	noir	-	1

Notes





Van Opstal & C° s.a.
Boomssteenweg 34, B- 2630 Aartselaar
T +32 (0)3- 887.40.48 • F +32 (0)3- 887.76.06 • E info@vanopstal.be
www.vanopstal.be

Sous réserve de modifications techniques.
Sauf erreurs et omissions.

Votre revendeur: